

20
Open Source Tools

Elektor

www.elektor.com

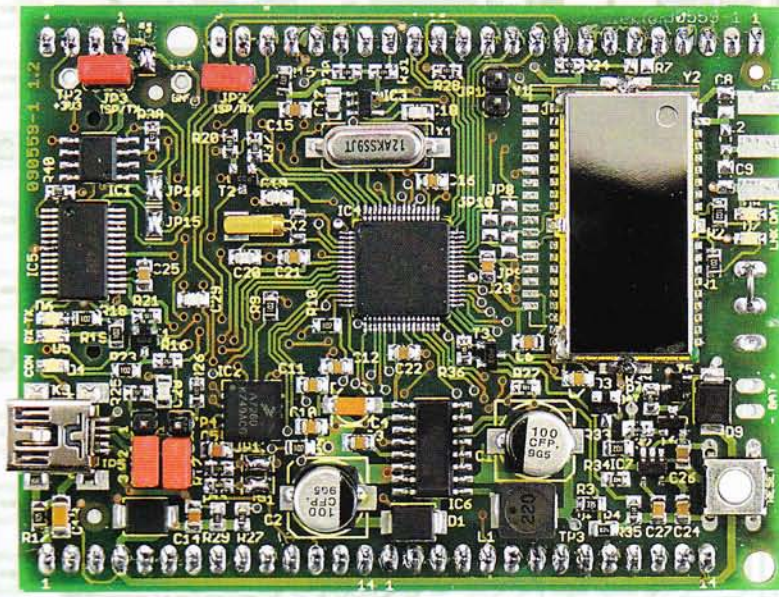

**LET THE
SCEPTRE
RULE!**

**A 32-bit ARM7
fast prototyping
system**

- + Low power design for AVR applications
- + LED Mixer with DMX Interface
- + Linux on a chip
- + Parking Radar

Ultra-compact ...

MODULO D

A full-fledged stereo amplifier

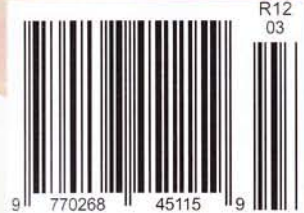

Motor Drivers/Controllers

Here are just a few of our controller and driver modules for AC, DC, Unipolar/Bipolar stepper motors and servo motors. See website for full range and details.

Computer Controlled / Standalone Unipolar Stepper Motor Driver

Drives any 5-35Vdc 5, 6 or 8-lead unipolar stepper motor rated up to 6 Amps. Provides speed and direction control. Operates in stand-alone or PC-controlled mode for CNC use. Connect up to six 3179 driver boards to a single parallel port. Board supply: 9Vdc. PCB: 80x50mm. Kit Order Code: 3179KT - £15.95
Assembled Order Code: AS3179 - £22.95



Computer Controlled Bi-Polar Stepper Motor Driver

Drive any 5-50Vdc, 5 Amp bi-polar stepper motor using externally supplied 5V levels for STEP and DIRECTION control. Opto-isolated inputs make it ideal for CNC applications using a PC running suitable software. Board supply: 8-30Vdc. PCB: 75x85mm. Kit Order Code: 3158KT - £23.95
Assembled Order Code: AS3158 - £33.95



Bi-Directional DC Motor Controller (v2)

Controls the speed of most common DC motors (rated up to 32Vdc, 10A) in both the forward and reverse direction. The range of control is from fully OFF to fully ON in both directions. The direction and speed are controlled using a single potentiometer. Screw terminal block for connections. Kit Order Code: 3166v2KT - £22.95
Assembled Order Code: AS3166v2 - £32.95



DC Motor Speed Controller (100V/7.5A)

Control the speed of almost any common DC motor rated up to 100V/7.5A. Pulse width modulation output for maximum motor torque at all speeds. Supply: 5-15Vdc. Box supplied. Dimensions (mm): 60Wx100Lx60H. Kit Order Code: 3067KT - £17.95
Assembled Order Code: AS3067 - £24.95



Most items are available in kit form (KT suffix) or assembled and ready for use (AS prefix).

Controllers & Loggers

Here are just a few of the controller and data acquisition and control units we have. See website for full details. Suitable PSU for all units: Order Code PSU445 £7.95

8-Ch Serial Isolated I/O Relay Module

Computer controlled 8-channel relay board. 5A mains rated relay outputs. 4 isolated digital inputs. Useful in a variety of control and sensing applications. Controlled via serial port for programming (using our new Windows interface, terminal emulator or batch files). Includes plastic case 130x100x30mm. Power Supply: 12Vdc/500mA. Kit Order Code: 3108KT - £64.95
Assembled Order Code: AS3108 - £79.95



Computer Temperature Data Logger

4-channel temperature logger for serial port. °C or °F. Continuously logs up to 4 separate sensors located 200m+ from board. Wide range of free software applications for storing/using data. PCB just 45x45mm. Powered by PC. Includes one DS1820 sensor. Kit Order Code: 3145KT - £19.95
Assembled Order Code: AS3145 - £26.95
Additional DS1820 Sensors - £3.95 each



Rolling Code 4-Channel UHF Remote

State-of-the-Art. High security. 4 channels. Momentary or latching relay output. Range up to 40m. Up to 15 Tx's can be learnt by one Rx (kit includes one Tx but more available separately). 4 indicator LED's. Rx: PCB 77x85mm, 12Vdc/6mA (standby). Two and Ten channel versions also available. Kit Order Code: 3180KT - £49.95
Assembled Order Code: AS3180 - £59.95



DTMF Telephone Relay Switcher

Call your phone number using a DTMF phone from anywhere in the world and remotely turn on/off any of the 4 relays as desired. User settable Security Password, Anti-Tamper, Rings to Answer, Auto Hang-up and Lockout. Includes plastic case. Not BT approved. 130x110x30mm. Power: 12Vdc. Kit Order Code: 3140KT - £74.95
Assembled Order Code: AS3140 - £89.95



Infrared RC Relay Board

Individually control 12 on-board relays with included infrared remote control unit. Toggle or momentary. 15m+ range. 112x122mm. Supply: 12Vdc/0.5A
Kit Order Code: 3142KT - £59.95
Assembled Order Code: AS3142 - £69.95



New! 4-Channel Serial Port Temperature Monitor & Controller Relay Board

4 channel computer serial port temperature monitor and relay controller with four inputs for Dallas DS18S20 or DS18B20 digital thermometer sensors (£3.95 each). Four 5A rated relay channels provide output control. Relays are independent of sensor channels, allowing flexibility to setup the linkage in any way you choose. Commands for reading temperature and relay control sent via the RS232 interface using simple text strings. Control using a simple terminal / comms program (Windows HyperTerminal) or our free Windows application software. Kit Order Code: 3190KT - £69.95



PIC & ATMEL Programmers

We have a wide range of low cost PIC and ATMEL Programmers. Complete range and documentation available from our web site.

Programmer Accessories:

40-pin Wide ZIF socket (ZIF40W) £14.95
18Vdc Power supply (PSU120) £19.95
Leads: Serial (LDC441) £3.95 / USB (LDC644) £2.95

USB & Serial Port PIC Programmer

USB/Serial connection. Header cable for ICSP. Free Windows XP software. Wide range of supported PICs - see website for complete listing. ZIF Socket/USB lead not included. Supply: 16-18Vdc. Kit Order Code: 3149EKT - £49.95
Assembled Order Code: AS3149E - £59.95

USB 'All-Flash' PIC Programmer

USB PIC programmer for all 'Flash' devices. No external power supply making it truly portable. Supplied with box and Windows Software. ZIF Socket and USB lead not included. Assembled Order Code: AS3128 - £49.95



See website for full range of PIC & ATMEL Programmers and development tools.

PICK UP YOUR **PIC** AND GO

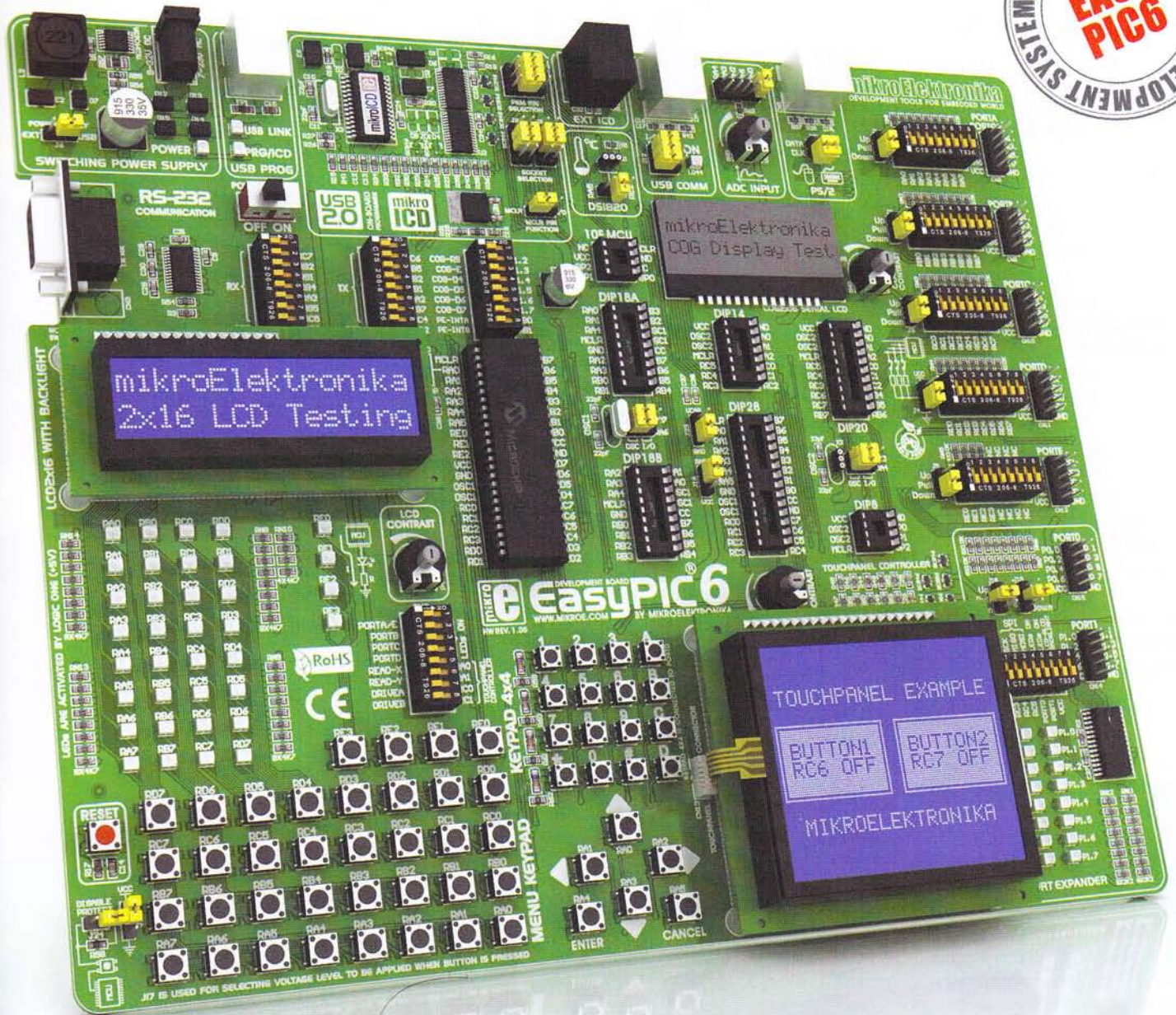

EasyPIC6 development system is a full-featured development system for 8-, 14-, 18-, 20-, 28- and 40-pin PIC microcontroller applications development and testing. The mikroICD (Hardware In-Circuit Debugger) enables very efficient step by step debugging. Examples in C, BASIC and PASCAL are provided with the board.

Experience the ease of creating your own electronic device **EasyPIC 6**

Publish your sources — nobody understands them anyway

Open Source is becoming so popular that even Microsoft, King of Closed-SourceSoftware, jumped the bandwagon, see page 14!

Why publish engineering details of your product? Many people hesitate to do it, mainly because they are afraid of copycats. This may be justified if the product depends on a proprietary development, but most products just combine several long established technologies.

I believe in Open Source. Like many other people I often use open source software. Like even more other people I hardly ever look at the source code files. Sometimes I do, but only briefly, because in general it is incomprehensible. Even small projects are often difficult to understand. You need a very good reason to invest time in studying someone else's source files.

So publish your source code files without fear — nobody will understand them anyway. Only a handful of users who will seriously attempt to understand your sources will succeed. Maybe one of them is your competitor. So what! When they finally get to understanding your code you're already working on new products based on enhanced, non-disclosed and vastly more complicated source files. You are advancing while your competitors are wasting their time.

To copy a TV you need more than a circuit diagram. You will need the components and the circuit boards as well as the tools to make the special parts, or to assemble the thing — not even mentioning the knowledge, skills and time needed to get the job done.

It's this same complexity that stands in the way of the widespread use of many open source projects. It is neither the parts nor the source code that determines the success of a project; it's the ease of use. Even the most brilliant projects will fail to attract many users if there's no proper manual, support or half a dozen examples. That is why we publish articles in Elektor instead of just circuit diagrams. Sometimes we even answer your questions.

This month Elektor has a focus on Open Source and fittingly we introduce our own open source project: the Sceptre. It all threatens to get complex, but we will do everything to keep it easy to use in terms of a project. We want the Sceptre to reign! Progress will be posted on <http://elektoreembedded.blogspot.com/>

Clemens Valens

Moderator, elektoreembedded.blogspot.com

elektor

6 Colophon

Corporate information on Elektor magazine.

8 News & New Products

A monthly roundup of all the latest in electronics land.

12 20 x Open Source

Essential links for developers of embedded systems.

16 Linux on a Chip

Get-u-going information on Embedded Linux.

20 Reign with the Sceptre

A 32-bit ARM7 fast prototyping system with high ambitions.

26 Modulo D

Very likely the world's smallest full-fledged stereo power amp.

34 LED Mixer with DMX Interface

With an MSP430 micro doing all the comms and PWM generating.

40 Starry Night

Create your very own mini Cosmos on the ceiling!

43 Escaped from the Elektor Lab

On bugs (the insect variety), transistor legs and a TI sports watch.

44 A look at the Altium Nanoboard 3000

Hear hear, Altium are cutting their prices!

46 Tackle the crackle — but do it properly

The three-step approach to noisy pots and wafer switches.

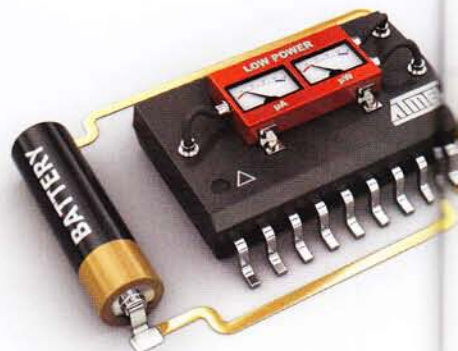
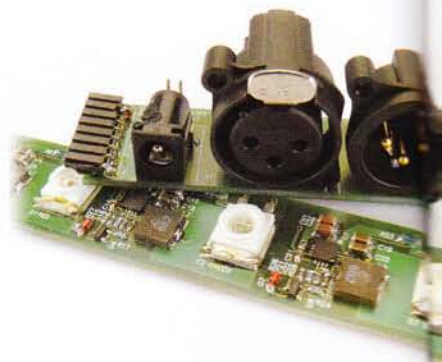
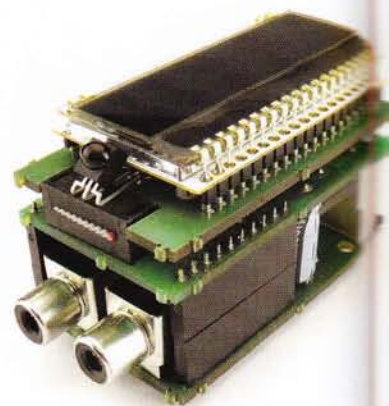
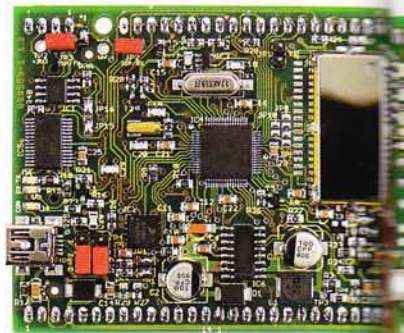

CONTENTS

Volume 36
March 2010
no. 399

20 Reign with the Sceptre

Meet the Elektor Sceptre, an ARM7 based open-source & open-hardware project that seeks to be a fast prototyping system, comprising user-friendly development tools and libraries that allow fast implementation of the board's peripherals.

26 Modulo D

Weighing only 150 grams (5.3 oz.), this audio amplifier module essentially consists of two application-specific ICs and an inexpensive ATmega8 microcontroller, which handles the control functions of the Class D amplifier.

34 LED Mixer with DMX Interface

The DMX LED lamp controller described here uses a TI MSP430 microcontroller to support DMX bus communication and generate PWM control signals for three power LED drivers. The DMX address can be set using DIP switches.

60 Every Microwatt Matters

Even cutting a single microamp from the current consumption of an AVR microcontroller circuit can be important in designs powered from batteries, Goldcaps, solar cells or 20 mA current-loop interfaces, and in designs that use so-called 'energy harvesting'. In this article we show what to watch out for, and what to look forward to.

48 An ATM18 Passepout

How to make the ATM18 board generate passwords and Tx on USB.

52 Small & Open Source

Meet Femto OS, Contiki, EtherNUT, FreeRTOS, BeRTOS and many more.

56 SPI, Microwire & Friends

An introduction into short-range buses.

60 Every Microwatt Matters

The how-to on low-power designing for AVR micros

66 Multifunction Switch

A smart switch for AC operated equipment.

70 Outmanoeuvred

Our Min Project this month describes a reversing aid for card.

73 Design Tips

Zener diode tester

74 Hexadoku

Our monthly puzzle with an electronics touch.

76 Retronics: Two Black Boxes

Regular feature on electronics 'odd & ancient'.

84 Coming Attractions

Next month in Elektor magazine.

Elektor International Media provides a multimedia and interactive platform for everyone interested in electronics. From professionals passionate about their work to enthusiasts with professional ambitions. From beginner to diehard, from student to lecturer. Information, education, inspiration and entertainment. Analogue and digital; practical and theoretical; software and hardware.

**ANALOGUE • DIGITAL
MICROCONTROLLERS & EMBEDDED
AUDIO • TEST & MEASUREMENT**

Volume 36, Number 399, March 2010 ISSN 1757-0875

Elektor aims at inspiring people to master electronics at any personal level by presenting construction projects and spotting developments in electronics and information technology.

Publishers: Elektor International Media, Regus Brentford, 1000 Great West Road, Brentford TW8 9HH, England. Tel. (+44) 208 261 4509, fax: (+44) 208 261 4447 www.elektor.com

The magazine is available from newsagents, bookshops and electronics retail outlets, or on subscription. Elektor is published 11 times a year with a double issue for July & August.

Elektor is also published in French, Spanish, American English, German and Dutch. Together with franchised editions the magazine is on circulation in more than 50 countries.

International Editor:
Wisse Hettinga (w.hettinga@elektor.nl)

Editor: Jan Buiting (editor@elektor.com)

International editorial staff: Harry Baggen, Thijs Beckers, Eduardo Corral, Ernst Krempelsauer, Jens Nickel, Clemens Valens.

Design staff: Antoine Authier (Head), Ton Giesberts, Luc Lemmens, Daniel Rodrigues, Jan Visser, Christian Vossen

Editorial secretariat:
Hedwig Hennekens (secretariaat@elektor.nl)

Graphic design / DTP: Giel Dols, Mart Schroijen

Managing Director / Publisher: Paul Snackers

Marketing: Carlo van Nistelrooy

Subscriptions: Elektor International Media, Regus Brentford, 1000 Great West Road, Brentford TW8 9HH, England. Tel. (+44) 208 261 4509, fax: (+44) 208 261 4447 Internet: www.elektor.com/subs

Elektor Tools for PCB Production

➔ PCB-DIY All the Way

£90 | \$150 | €100 DISCOUNT
with your combined order of the stencil machine and pick & place tool!

It's clear that a good set of tools is required for PCB production and SMD component stuffing. With the Elektor stencil machine you get the solder paste accurately positioned, and the pick & place device is ideal for manual fitting of SMT components on circuit boards.

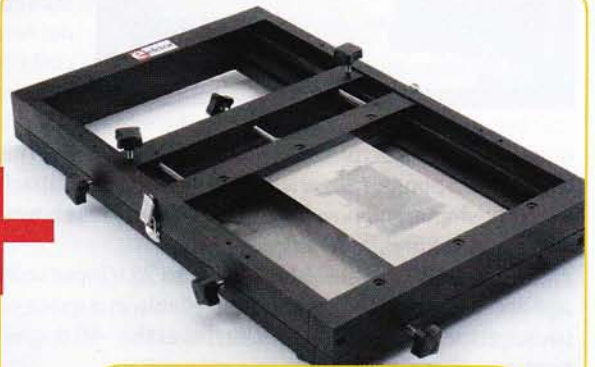

Elektor Pick & Place Tool

For manual fitting of SMT components on circuit boards

- Adjustable anti-static arm rest for stable positioning of components
- Anti-static component storage system
- Magnetic supports for PCB
- Suction tool with different pickup needle sizes
- Maintenance-free vacuum pump
- Kit of parts for home assembly, with clear manual

450 x 350 x 100 mm | 2.5 kg
£575.00 | US \$935.00 | €645.00*

*Prices including VAT (EU destinations), excluding shipping.



Elektor Stencil Machine

Use a stencil for accurate applying of solder paste on circuit boards

- Accurate X,Y alignment of PCB frame
- For single and double sided PCBs and single-sided populated PCBs
- Magnetic standoff supports for PCB
- Rapid and secure fixing of stencil
- Stencils do not need fixing holes
- Maintenance-free and robust aluminum frame
- Kit of parts for home assembly, with clear manual

450 x 300 x 60 mm | 5.5 kg
£395.00 | US \$645.00 | €445.00*

elektor

Further information and ordering at
www.elektor.com/pcbtools

Email: subscriptions@elektor.com
Rates and terms are given on the Subscription Order Form.

Head Office: Elektor International Media b.v.
P.O. Box 11 NL-6114-ZG Susteren The Netherlands
Telephone: (+31) 46 4389444. Fax: (+31) 46 4370161

Distribution:
Seymour, 2 East Poultry Street, London EC1A, England
Telephone: +44 207 429 4073

UK Advertising:
Huson International Media, Cambridge House,
Gogmore Lane, Chertsey, Surrey KT16 6AP, England.
Telephone: +44 1932 564999. Fax: +44 1932 564998

Email: r.elgar@husonmedia.com
Internet: www.husonmedia.com
Advertising rates and terms available on request.

Copyright Notice
The circuits described in this magazine are for domestic use only. All drawings, photographs, printed circuit board layouts, programmed integrated circuits, disks, CD-ROMs, software carriers and article texts published in our books and magazines (other than third-party advertisements) are copyright Elektor International Media b.v. and may not be reproduced or transmitted in any form or by any means, including photocopying, scanning or recording, in whole or in part without prior written permission from the Publisher. Such written permission must also be obtained before any part of this publication is stored in a retrieval

system of any nature. Patent protection may exist in respect of circuits, devices, components etc. described in this magazine. The Publisher does not accept responsibility for failing to identify such patent(s) or other protection. The submission of designs or articles implies permission to the Publisher to alter the text and design, and to use the contents in other Elektor International Media publications and activities. The Publisher cannot guarantee to return any material submitted to them.

Disclaimer
Prices and descriptions of publication-related items subject to change. Errors and omissions excluded.

© Elektor International Media b.v. 2009 Printed in the Netherlands

Low-cost, synchronous DC-DC regulator delivers up to 3 A in a 3mm² package



Maxim Integrated Products introduces the MAX15041, a synchronous DC-DC converter with integrated MOSFETs in a small 3mm x 3mm package. The built-in MOSFETs offer higher efficiency (93%) than asynchronous solutions, while simplifying design and minimizing EMI. Capable of delivering up to 3 A, the MAX15041 is ideally suited for a variety of point-of-load applications including telecom and networking equipment, as well as low-cost consumer products.

This device operates from a fixed 350 kHz PWM frequency and utilizes a peak-current-mode architecture to simplify compensation. This topology ensures excellent load transient response, thus enabling an all-ceramic-capacitor design. Other features include an enable input and power-good indicator. This converter also offers the ability to safely start up into a prebiased output.

The MAX15041 operates from a 4.5 V to 28 V input voltage and provides $\pm 1\%$ output-voltage accuracy over temperature. Available in a space-saving, 3mm x 3mm, 16-pin TQFN package, the device is fully specified over the -40 degrees to $+85$ degrees Celsius extended temperature range.

www.maxim-ic.com/MAX15041

(091076-X)

8-channel driver for ten 100mA LEDs with 3000:1 true colour PWM dimming

Linear Technology's LT3760 is an 8-channel LED driver, utilizing a step-up DC/DC controller capable of driving up to a 45 V string of 100 mA LEDs per channel. Its internal 60 V, 1 MHz DC/DC boost mode controller is designed to operate as a constant current LED driver for up to 80 white LEDs. From a 12 V input, the LT3760 can drive 8 channels, each with up to ten 100 mA white LEDs in series while delivering efficiencies exceeding 92%. Its multichannel capability makes it ideal for medium and large-sized TFT-LCD backlighting applications. Its input voltage range of 6 V to 40 V is ideal for automotive, avionic, HDTV and industrial display applications.

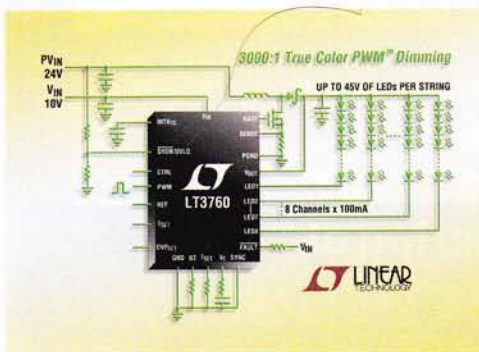

The LT3760 offers $\pm 2.0\%$ ($\pm 0.7\%$ typical) LED current matching to ensure uniform brightness of the display. Dimming ratios as high as 3,000:1 can be attained by using True Color PWM™ dimming. A programmable 100 kHz to 1 MHz fixed frequency operation and current mode architecture offers stable operation over a wide range of supply and output voltages while minimizing the size of the external components. Additionally, the switching frequency is synchronisable to an external clock. Its thermally enhanced TSSOP-28 package offers a highly compact solution footprint for most LED backlighting applications.

The LT3760EFE is available in a thermally enhanced 28-lead TSSOP package. An industrial grade version, the LT3760IFE is tested and guaranteed to operate from a -40°C to 125°C operating junction temperature.

www.linear.com

(091076-XI)

Big, bigger, BIGAVR6

mikroElektronika is proud to announce the BIGAVR6 Development System as an addition to its AVR development tool product line.



The new BIGAVR6 supports 64 and 100-pin AVR devices (TQFP packaged) and gives designers an easy to use platform to try a multitude of designs.

The BIGAVR6 includes new features such as: CAN Module, Serial EEPROM, RTC and many more. Each feature of the board is supported by example written in mikroC PRO, mikroPascal PRO and mikroBasic PRO compiler for AVR. Also, BIGAVR6 comes with the full colour printed documentation.

The system price is US\$139.00 and it is available for purchase on the mikroElektronika website and through authorised distributors.

www.mikroe.com

(091103-I)

ISP/JTAG programmer & boundary scan test platform

Atomic Programming's new portable all-in-one solution is for In-System Programming (ISP) of both JTAG and non-JTAG devices, Boundary Scan Testing and out of system device programming.

Available now, the AP-114 offers JTAG Programming, configuration and testing for all compatible devices. The supplied software supports STAPL, JAM, JBC and SVF files. Universal support for non-JTAG devices is also provided and includes Serial Flash and EEPROMs, Altera EPCS and Xilinx configuration SPROMs and Atmel AVR microcontrollers.

Optional Boundary Scan software provides a powerful but low cost JTAG test solution



for production and debugging applications. Additional features include serial number handling, user and product log files for audit trails and a Netlist importer.

Control is achieved through a fully flexible graphical user interface (GUI), which can also be easily integrated into a users own system software for even greater flexibility. The software runs on Windows 7, Vista, XP, Server 2003 and 2000.

Other features include a Generic GDB Proxy server, and with an additional cable assembly and SDK, the AP-114 can be used to debug the Jennic JN5148 ZigBee Wireless Microcontroller. A training platform is also available and provides everything required to help understand JTAG Boundary scan testing and FPGA configuration and ISP programming, as well as a development kit for Jennic ZigBee PRO applications.

Manufactured in the UK, the programmer is RoHS compliant and CE approved and is powered from the USB Port.

Dimensions are 83 x 52 x 16 mm, and weight is 200 g (8 oz).

www.atomicprogramming.com (091103-II)

Atmel MCUs feature integrated wireless interface

Atmel's new family of AVR wireless microcontroller (MCU) devices is targeting wireless applications such as ZigBee and IPv6/6LoWPAN. The ATmega128RFA1 is IEEE 802.15.4 compliant and combines Atmel's picoPower AVR MCU with a 2.4 GHz RF transceiver.

Atmel's picoPower technology offers ultra-low power consumption to enable longer battery life for wireless ZigBee applications, including smart energy, building automation, telecom and health care. The ATmega128RFA1 is supported by Atmel's QTouch Library, making it easy to combine capacitive touch functionality with RF in a single chip.

The ATmega128RFA1 combines Atmel's IEEE802.15.4 2.4-GHz transceiver with an AVR MCU on a single chip. The single-chip design enables designers to save board space and reduce the overall system component count so savings can be passed on to customers. In addition, these devices include a low-power, high performance AVR MCU with embedded flash memory.

Other key features include a long-range, high performance RF transceiver to ensure a reliable wireless link and low current consumption for extended battery life. The

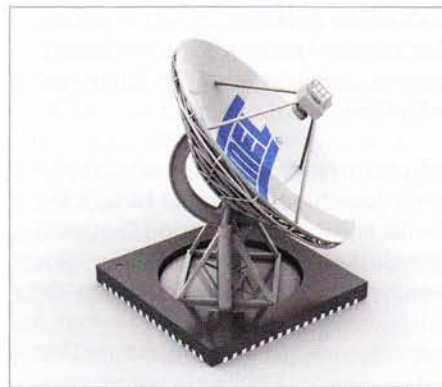

MCUs in these devices can operate at low supply voltages without compromising performance. Finally, a wake-on-radio function enables autonomous RF transmission and reception, further reducing power consumption by keeping Trx RF active while the microcontroller remains in sleep mode.

www.atmel.com

(091103-III)

Parallax Xbee USB adapters and modules

The new Xbee USB Adapter Board from Parallax is compatible with any of their Xbee RF modules, and provides a means to connect the Xbee to a computer via a simple USB A to Mini-B cable. Once connected, this adapter board can be used to either configure the device using the X-CTU software available from Digi, or to use a computer to communicate with other Xbee modules. The adapter retails at US\$24.99.

This board is kitted with two 10-pin sockets with 2 mm spacing which can be soldered to the PCB for easy mounting of the Xbee RF Module. Also included is one 40-pin header with 0.1" spacing which can be soldered to the PCB for easy accommodation to a breadboard. Therefore, basic sol-

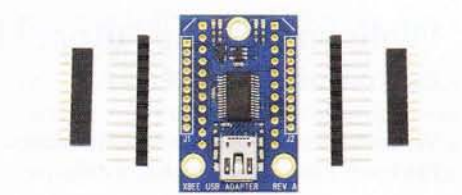

dering knowledge and tools are required for this product. A non-USB version of the Xbee Adapter Board (#32403) is also available. On the Parallax website, search for 'USB Adapter' (32400).

The new Digi Xbee 802.15.4 modules provide two friendly modes of communication – a simple serial method of transmit/receive or a framed mode providing advanced features. Xbees are ready to use out of the package, or they can be configured through the X-CTU utility or from your microcontroller. These modules can communicate point to point, from one point to a PC, or in a mesh network. And, all of the modules sold by Parallax are compatible with one another!

Choosing the right Xbee module is best accomplished by taking a look at the Xbee Comparison Chart available on the Parallax website. You only need to choose an antenna style (chip or wire) and power level (1 mW for up to 300 ft and 60 mW for up to 1 mile).

Because the Xbee modules have 2 mm pin spacing, it's recommend to use an adapter board for each module. The adapter boards available provide several advantages to the Xbee modules such breadboard-friendly standard 0.1-inch pin spacing, mounting holes, and easy-to-solder connections. Even if you are communicating point-to-point without a PC, you should always have at least one Xbee USB Adapter Board (#32400) so you can easily configure and test each Xbee module prior to putting it in a point-to-point application. search for 'Xbee' or 32404, 32405, 32406, 32407. The new modules retail at US\$19.00 and US\$32.00.

www.Parallax.com

(091103-IV)



Wolfson signs up Future Electronics as a global distribution partner

Wolfson Microelectronics recently signed a franchise agreement that makes Future Electronics its primary global distributor.

The franchise agreement is effective immediately and Future Electronics is authorised to sell all Wolfson products globally. The new partnership with Future Electronics is part of a drive by Wolfson to widen its customer base and address the proliferation of audio and mixed-signal applications in consumer and industrial products.

Andrew Bickley, Sales Director (Europe) at Wolfson, said: "High performance audio and mixed-signal semiconductor solutions are no longer only found in portable music players and hi-fis; they are being designed into hundreds of products, from TVs and set-top boxes, to mobile phones and mobile accessories, car infotainment, secure-access systems and medical electronics devices. This broad base of potential customers needs the technical and logistical support of a top-ranking, global technical distributor, and that is why we have chosen to franchise Future Electronics."

Wolfson selected Future Electronics because of its expertise in technical sales, in particular its teams of Field Applications Engineers in local branches across Europe, the Middle East, Africa (EMEA), the Americas and Asia; and its System Design Centres in Egham (UK) and Montreal (Canada), which provide design services and Future-Blox development boards to customers, and Asia which provides turn-key design services and proof of concept designs.



Picture, left to right: Andy Keenan, VP of Marketing, Future Electronics (EMEA); Dan Casey, Managing Director, Future Electronics (EMEA); Mike Hickey, CEO, Wolfson Microelectronics; Andy Brannan, Chief Commercial Officer, Wolfson Microelectronics.

www.wolfsonmicro.com www.futureelectronics.com

(091103-V)

OSRAM ORBEOS OLED launched by RS Components

RS Components have effectively launched the new OSRAM ORBEOS OLED (Organic LED) lighting tile and the product is now available on RS websites.



The ORBEOS is a new lighting tile ideally suited to designer luminaires, decorative lighting and mood lighting. Extremely thin and flat, with very low heat dissipation, OLEDs can be embedded into most materials with ease. With an instant on/off function, plus high quality of light, this ambient light can become an integral part of objects and architecture.

rswww.com/electronics

www.osram-os.com

(091103-VI)

Low cost, high performance ISM band RF modules at 2.4 GHz

Radiocrafts AS have expanded their product line with two new modules, the low cost RC2500-RC232 and RC2500HP-RC232. These are multi-channel RF transceivers with embedded protocol. RC2500 is below US\$10 in volume. RC2500HP includes a range extension LNA and 100mW PA. The new modules have numerous applications in M2M communication, sensor and control networks.

The module is a complete RF system solution including a high performance multi-channel FSK radio transceiver and a packet protocol handler, with an easy-to-use UART interface. The embedded RC232™ protocol provides a point-to-multipoint solution with individual addressing or broadcast, and CRC check for signal integrity. The module can also be used as a wireless RS232 / RS485 cable replacement.

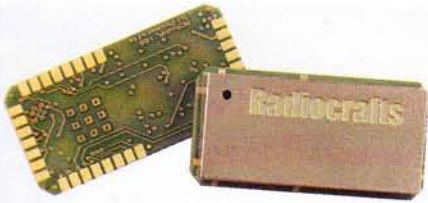

The compact modules, measuring only 12.7 x 25.4 x 3.3 mm, makes up a complete RF modem in one single tiny package, replacing tens of components compared to a discrete design. No external components are required, except an antenna. The modules are delivered on tape and reel for efficient volume production. It's small size and low power consumption makes it ideal for integration into size constrained battery operated equipment. The modules are based on a new very low cost platform, and have been developed for volume applications with a price target of less than US\$10 at 50 k. The new modules are pin compatible with the RC11x0 series giving the customer a complete range of replaceable modules at 433, 868, 915 and 2450 MHz. The RC2500-RC232 and RC2500HP-RC232 (set to 10 mW) are pre-certified for operation under the European radio regulations for license-free use. When used with quarter-wave antennas a line-of-sight range of 1000 and 3500 metres, respectively, can be achieved at low data rates. Both modules are also designed for operation under the FCC regulations.

Modules and Demo Kits are available now.
www.radiocrafts.com (091103-VIII)

antenna designer kit. This sample kit integrates different kind of antennas suitable for applications in Passive Keyless Entry Systems, Keyless Go as well as immobilizers.

The kit includes door handler antennas, trunk antennas, SMD emitter antennas, interior antennas and bumper antennas that have been developed with a frequency between 21 kHz, 125 kHz and 134.2 kHz and can operated in a temperature range between -40°C to +85°C.

These antennas are available in two versions, overmoulded, with connector integrated in the enclosure to assure the IP67 requirements and mechanical robustness, and potting, with connector located outside the assembly housing plastic base. All of them have been designed to meet the strictest qualification test (mechanical, thermal, waterproof, chemicals ...) and optimised to allow long reading distances in the smallest volume.

The emitter antennas with frequencies of 125 kHz are included in Atmel development kits, NXP (345uH) and Austria Microsystems (KGEA-BFCR-B-0500J). Also, emitter antennas with frequencies of 134 kHz and 20 kHz, are included in Texas Instruments and Austria Microsystems development kits.

www.grupopremo.com (091103-IX)

Emitter antenna designer kit for automotive electronics

Developers of automotive electronics applications could benefit from our emitter

UMTS/HSDPA modem supports 7.2 Mb/s download speed

u-blox announces LUCY, a new family of high-speed wireless modules supporting the world's fastest globally adopted mobile communications standard.

Based on UMTS/HSDPA, LUCY supports a wide range of M2M applications such as high-bandwidth multimedia systems for mobile Internet and VoIP routing, in-car multimedia as well as streaming video for remote media panels and transfer of large data volumes for medical diagnostics, security and surveillance.

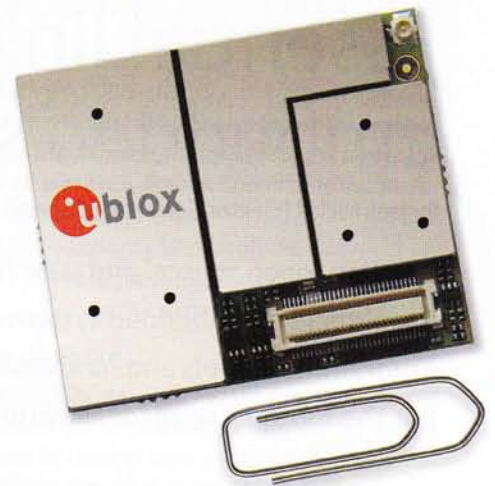

LUCY supports tri-band UMTS/HSDPA and quad-band GSM/GPRS/EDGE class 12 with embedded TCP/IP stack and SSL client. A key feature of LUCY is its low idle-mode power consumption of less than 2 mA, and wide operating voltage, 3.2 to 4.5 V. The module includes an assisted GPS client for on- and offline telematics applications, and comes in a compact 45 x 37.5 x 3 mm package with 60-pin board-to-board connector. The highly-integrated module supports both voice and data, and requires only an external antenna.

Availability of samples and evaluation kit is announced as end of April, 2010

www.u-blox.com (091103-X)

Advertisement

Prototype & small series PCB specialists

EURO
CIRCUITS

PCB proto	dedicated prototype service
STANDARD pool	widest choice 1 - 8 layers
New TECH pool	100 µm technology
New IMS pool	metal-backed PCBs
On demand	all options up to 16 layers

Call us: 020 8816 7005 Email: euro@eurocircuits.com
 New website - new services

ALL SERVICES

- Instant online pricing
- Instant online ordering
- Low pooling prices
- Deliveries from 2 days
- No tooling charges
- Stencil service

www.eurocircuits.com



20 x Open Source

Essential links for developers of embedded systems

By Jens Nickel (Elektor Germany Editorial)

Mention 'open source' and your first thoughts are probably of a software application running on a PC. Developers of embedded systems should be aware that there is a wide range of open source programs, programming tools and hardware platforms now available. Not only do you save the cost of a user licence but the forums are an ideal learning resource. We asked some engineers which products they rated.

Open source software offers a number of advantages: The product is independent of a particular manufacturer, there are no licence costs and the product is usually of a high quality because it is often supported by a large and active community of users. When a program's source code is available it gives you the chance to fix any errors, change the behaviour of the program or even add new features. Providing the open source code is not too complex you will certainly learn a great deal from the experience. This alone should be a good reason for any designer of microcontroller applications to consider the advantages of using open source software. PC tools such as editors, documentation programs, toolchains (for the vast majority of microcontrollers), operating systems and libraries are available in

large numbers with open source code. We also need to mention the growing array of open source hardware including microcontroller boards where the circuits, PCBs and CAD files are made available to the user who in turn is free to modify, improve or add more features for a particular application. Open source hardware is always supported by software code and libraries so that newcomers to the system can be up and running very quickly. Any attempt to give meaningful overview of all the available open source resources would be doomed to failure in an article of this size; there is just too much material for so many different systems and platforms. Instead we asked four engineers to name the open source projects they had personally benefited from and would recommend.

Maybe you too have had a good experience using these resources or maybe you feel we have overlooked a gem that deserves wider recognition, whatever the case please let us know.

Hardware

(suggestions by Clemens Valens, Elektor France Editorial)

Arduino

This very popular platform offers a range of simple microcontroller and development boards (these can be purchased ready-built from some suppliers). The site has an active forum and the wide range of software examples will ensure that you are up and running in minimum time.

<http://arduino.cc>

Licensing

Although the use of open source software (OSS) indicates that there are no royalties or fees payable for their use there are only really a few programs which have no restrictions on how they are used. The majority of OSS has a license which controls how the program can be used. The most well known of these is the GNU General Public License (GPL). This quite strict licence allows you to modify or expand the original program providing the modified program is also published with a GPL. Included in this are any programs running in a GPL protected operating system or any programs which use a GPL

library. Anyone planning to market an embedded project for commercial gain would do well to familiarise themselves with the finer details of the appropriate licenses, it may be prudent to seek specialist legal advice before any commitment is signed and sealed.

For purely evaluation purposes (or for hobby use) there are essentially no restrictions on use of the software. In any case it is necessary to make reference to the copyright and licence in the source code.

A good overview can be found on the Open Source Initiative (OSI) Website: www.opensource.org/licenses/alphabetical.



Openmoko

Nothing less than a complete software stack for a smart phone is the open source project being developed here. The Neo FreeRunner mobile phone is the target hardware platform. Development and debug boards are also available.

www.openmoko.org

GNU Radio & Universal Software Radio Peripheral

The GNU Radio project is a software toolkit to produce a software defined radio. The open source hardware for this project is the USRP-Board (Universal Software Radio Peripheral) which is based on an FPGA.

www.gnuradio.org

KiCAD

This is one of the best known suites of CAD programs for hardware production. Tools for generating circuit diagrams and PCBs are all included. 3D representations of the finished board can also be viewed.

<http://kicad.sourceforge.net/wiki/index.php>

Fab Lab

Very interesting and unusual this project offers 3D laser cutters, 3D printers and other machines for general usage by the public. In open source tradition details of objects made become publicly accessible. Very useful for

making robot parts and art objects.

<http://fab.cba.mit.edu>

Libraries & run time tools

(suggestions by Benedikt Sauter, www.ixbat.de)

uIP/lwIP

Two outstanding network stacks, the first is for 8-bit microcontrollers. lwIP is a development of the first and more suited to medium sized controllers. The uIP licence is not so strict allowing the stack to be used in commercial products.

www.sics.se/~adam/uip

www.sics.se/~adam/lwip/

LUFA (formerly MyUSB)

A large library of applications for interfacing (both Host and Device) USB enabled AVR controllers. The demonstration applications allow an AVR controller for example to emulate a keyboard and many other devices (mass storage device, audio I/O etc.)

www.fourwalledcubicle.com/LUFA.php

USB stack for LPC2148

ARM fans should take a look at the USB library

here. Written for the Philips LPC2148 which has an ARM7 compatible core.

<http://wiki.sikken.nl/index.php?title=LPCUSB>

Crypto-avr-lib

A library of optimised cryptographic routines for the ATmega controller. Issued under the GPL Version 3, licence. Contact the author for other types of licence.

<http://www.das-labor.org/wiki/AVR-Crypto-Lib/en>

FreeRTOS

FreeRTOS is a lightweight Real Time kernel which can run on many controller families. It can be used in commercial applications and allows the use of closed-source software.

www.freertos.org

A list of many more Open Source operating systems can be found elsewhere in this magazine!

U-Boot

Universal bootloader with a large range of routines for memory, UART interface, SD card, network and USB etc. Conceived originally as a bootloader but now through comprehensive hardware support can be used as the basis of a C code module.

www.denx.de/wiki/U-Boot



Arduino: Simple hardware, C-like programming language, good forum.

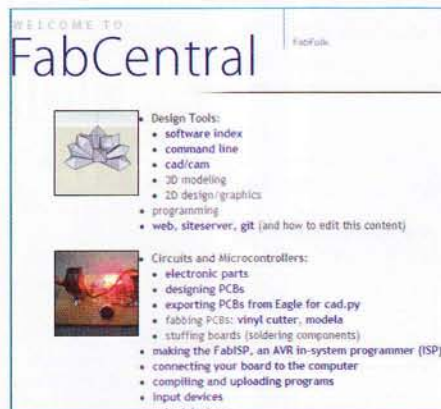

Fab Lab: Free fabrication plant for open source projects.



LUFA: Lightweight USB for AVRs – lots of code examples.

MICROCONTROLLERS

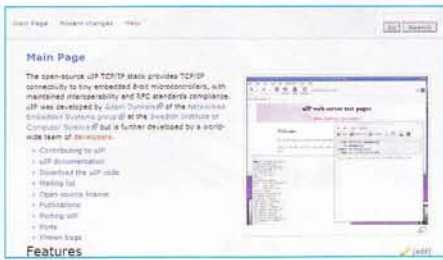

uIP: TCP/IP for 8-bit-Controller – with well documented code.

Embedded Filesystems Library

A very useful (FAT-) file format, when you are short of memory. The GPL licence includes a clause allowing static linking to the library without public disclosure of your code.

<http://efsl.be>

.NET Micro Framework

Now open source this very compact, trimmed-down .NET Framework running on diverse ARM platforms. Programmable using the object orientated C variant C#; lots of resources including support for I2C, Ethernet and many more. Helps reduce development time.

www.microsoft.com/netmf/default.msp

PC tools

(suggestions by Antoine Authier and Jerry Jacobs, Elektor Labs)

Eclipse

This is a good development environment. It has a modular structure which makes it very easy to configure. There are around 1,000 plug-in modules (both open source and commercial) for a range of program languages and target systems. See also the Elektor article in October 2006.

www.eclipse.org

www.elektor.com/060018



Eclipse: Powerful software development environment with 1000 plug-ins.



.NET Micro Framework: Open Source from Microsoft.

Kdevelop

Kdevelop is an integrated development environment which should satisfy most power-user needs. Runs in MS Windows, Mac OSx, Linux, Solaris and FreeBSD. Plug-in expandable.

www.kdevelop.org

Programmer's Notepad

A lightweight but efficient editor for writing source code. Allows fast, simple and comfortable program production. Can be expanded with plug-ins.

www.pnotepad.org

Doxygen

An intelligent tool which can automatically generate code documentation (C, C++, Java etc.). The programmer provides tags in the source file; Doxygen generates the comprehensive documentation in PDF or HTML format. It can also extract the code structure from undocumented source files.

www.stack.nl/~dimitri/doxygen

WinMerge

A good tool for code comparison and code synchronisation. The program can also compare the contents of folders/files and display the results in a visual text format that makes it easy to understand.

<http://winmerge.org/>



Programmer's Notepad: Regular expressions, Unicode and other features.

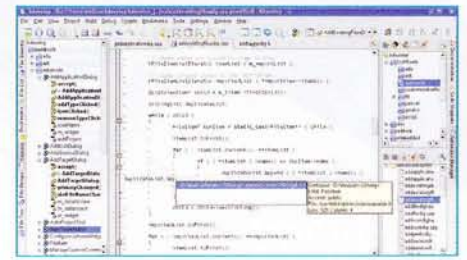

Kdevelop: Automatic code completion and much more (photo: kdevelop.org).

Tera Term

A terminal program to access COM ports, supports Telnet communication Protocol. A debugging tool to eavesdrop on serial communications.

<http://tssh2.sourceforge.jp>

GNU Toolchains

Toolchains for GNU projects are available most processor architectures AVR, Coldfire, ARM, MIPS, PowerPC and Intel x86. The GNU-toolchain includes not only compilers for C, C++ and in most cases also Java (GCC = GNU Compiler Collection), but also Linkers, Assemblers and Debuggers together with C libraries (libc = C library). The tools are used from within other open source projects like WinAVR which gives a familiar user interface to speed program development.

GNU Compiler Collection:

<http://gcc.gnu.org>

WinAVR:

<http://winavr.sourceforge.net>

Yet another GNU ARM toolchain:

www.yagarto.de

(091033)

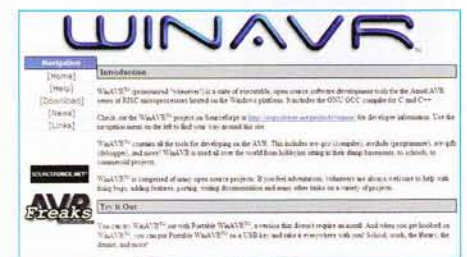

WinAVR: Compiler, Debugger, Programmer – everything for AVR developers.

FRONT PANELS & HOUSINGS

Cost-effective single units and small production runs

Customized front panels can be designed effortlessly with the Front Panel Designer. The Front Panel Designer is available free on the Internet or on CD.

- automatic price calculation
- delivery in 5-8 days
- 24-Hour-Service if required

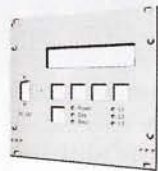

Sample price: 32,50 € plus VAT/shipping

Schaeffer AG · Nahmitzer Damm 32 · D-12277 Berlin · Tel +49 (0)30 805 8695-0
Fax +49 (0)30 805 8695-33 · Web info@schaeffer-ag.de · www.schaeffer-ag.de

www.
elektor.
com

NURVE NETWORKS LLC

XGAMESTATION

Powered By
Atmel MEGA AVR 644
64K FLASH
4K SRAM

AVR 8-BIT

XGS AVR 8-Bit Main-PCB Board.
XGS Gamepad Controller.
325+ Page Printed Manual.
Atmel AVR ISP MKII Programmer.
9V Power Supply & A/V Cable.
PC Serial Port to XGS Converter.
PC DVD-ROM.
1GB Micro SD Card + Adapter.
Bonus: eBooks on Hardware,
Game Console Design, and More!

Visit Youtube
Channel:
XGSDEV

THE MOST COMPLETE ATMEL MEGA AVR DEV KIT AVAILABLE!

WWW.XGAMESTATION.COM

The new PicoScope 4000 Series high-resolution oscilloscopes

PicoScope 4000 Series

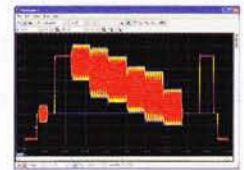
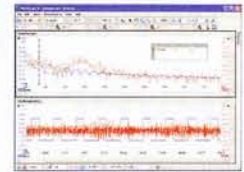
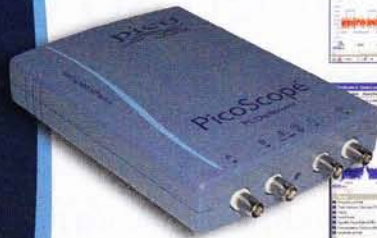

The PicoScope 4224 and 4424 High Resolution Oscilloscopes have true 12-bit resolution inputs with a vertical accuracy of 1%. This latest generation of PicoScopes features a deep memory of 32 M samples. When combined with rapid trigger mode, this can capture up to 1000 trigger events at a rate of thousands of waveforms per second.

- **PC-based** - capture, view and use the acquired waveform on your PC, right where you need it
- **Software updates** - free software updates for the life of the product
- **USB powered and connected** - perfect for use in the field or the lab
- **Programmable** - supplied with drivers and example code

Resolution	12 bits (up to 16 bits with resolution enhancement)
Bandwidth	20 MHz (for oscilloscope and spectrum modes)
Buffer Size	32 M samples shared between active channels
Sample Rate	80 MS/s maximum
Channels	PicoScope 4224: 2 channels PicoScope 4424: 4 channels
Connection	USB 2.0
Trigger Types	Rising edge, falling edge, edge with hysteresis, pulse width, runt pulse, drop out, windowed

www.picotech.com/scope1059
01480 396395

Linux on a chip

Development has never been so easy!

By Jerry Jacobs (Elektor Labs) &
Thijs Beckers (Elektor Netherlands Editorial)

Linux on a chip is much more common than you might think. It's very likely that your ADSL modem or router makes use of it. And the same applies to that advanced Smartphone in your pocket that uses Google Android. In this article we'll show you how you can quickly get started with Embedded Linux yourself.

In this article we make use of a nanoLIAB board made by Linux-in-a-Box^[1]. The processor on this board is an AT91RM9200 ARM micro-controller. On board we find a 10/100Mbit Ethernet controller, a serial port and an audio DAC. The board also contains 16 MBytes FPRAM flash and 32 MBytes RAM. This board is perfect for beginners because it comes with excellent documentation and has Embedded Linux^[2] pre-installed so that you can get started right away.

Booting

After applying power to the board, the boot loader starts with initialising the hardware. The boot loader then loads the kernel. One function of the kernel is to act as an interface between the application software and the underlying hardware. It is started when the boot loader jumps to the location in RAM where the kernel has been loaded. You can follow the progress of the boot loader and kernel via the serial port (see **Figure 1**). As you can see, the boot loader displays some kernel parameters, such as the MAC address, an IP address and the directory from which the rest of the applications are loaded.

We used a system with Ubuntu Linux^[3] as the host system and ran a terminal emulator to start an interactive session with the nanoLIAB board. In this session you can pass on commands to the board and change its settings. The interactive session occurs via the serial port. On the Ubuntu machine you run the command `'cu -l /dev/ttyS0 -s 115200'`, which creates a connection via serial port ttyS0 (this is the Linux equivalent of the COM1 port found in a Windows-based system). When the board is connected to a different serial port the 'ttyS0' should be replaced with the corresponding serial port to which the board is connected. If the serial port you're using was created via a USB adapter, you should use the name 'ttyUSB' followed by the port number.

Installation

In theory it is possible to modify the firmware and to transfer the data via the serial interface to the flash memory of the board. To do this we would first have to convert the binary image into ASCII

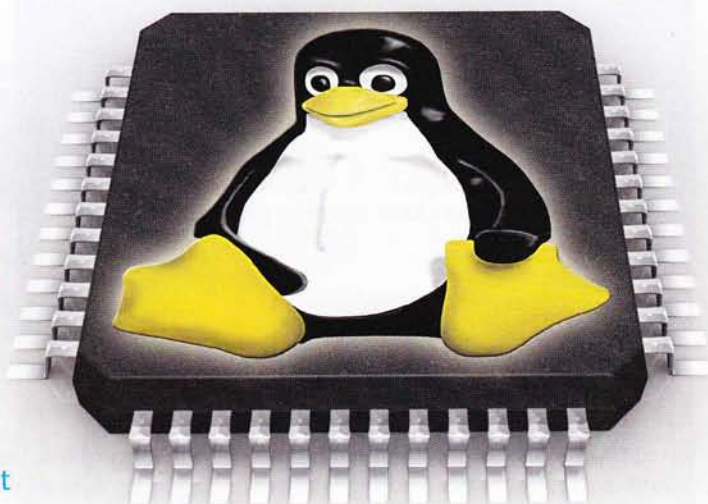

(uuencode), because the transfer via the serial port is text-based. However, since the board already comes installed with a stable working system and all compiled applications function correctly, we saw no need to modify the firmware.

Applications

In **Listing 1** is an example of how easy it is to write a 'program' by creating a small script for a console application. The script can be transferred from the computer to the board via an ftp program (the board has an ftp running). Keep in mind that the transferred files end up in the working memory rather than the flash memory. When the power is removed the program will therefore disappear.

Using the command `tar -c led_counter.tar led_counter.sh` the script is put inside a tar archive^[4] on the PC to make sure the line endings are correct. When the serial session has completed the transfer of the archive to the board it can be unstuffed on-board with the com-

```

jerry@ubuntu: ~
File Edit View Terminal Help
-----o LIAB Bootloader o-----
Release: 1.0, April 18, 2007 at 13:52 by root
Copyright LIAB Aps.

GZIP image no. 1 found at addr 0x00020000
Filename .....: vmlinux.bin
Timestamp .....: Apr 18 11:51:51 2007 UTC
Bootloader: now putting Linux boot tags at 20000100
Starting Linux kernel ...
Linux version 2.6.16 (root@msa) (gcc version 3.3.2) #1 PREEMPT Wed Apr 18
13:51:50 CEST 2007
CPU: ARM920Tid(wb) [41129200] revision 0 (ARMv4T)
Machine: Atmel AT91RM9200-DK
Clocks: CPU 165 MHz, master 55 MHz, main 14.745 MHz
CPU0: D VIVT write-back cache
CPU0: I cache: 16384 bytes, associativity 64, 32 byte lines, 8 sets
CPU0: D cache: 16384 bytes, associativity 64, 32 byte lines, 8 sets
Kernel command line: liabETH=00:90:82:FF:04:81
liabIP=192.168.1.180,8,192.168.1.1 liabHOST=liab.liab.dk
liabJFFS2=/jffs2 liabRUN=/jffs2/StartApplication

```

Figure 1. During the loading of the kernel we see various settings and status information scroll past.

mand `tar -xzf led-counter.tar`. Next you have to set the execute bit of the script, otherwise you can't run it. This is done using the command `chmod +x led-counter.sh`. You can now execute the script with the command `./led-counter.sh`.

Device drivers

Devices and kernel settings under Linux can usually be accessed via virtual files and directories. Each device is allocated a virtual file in the `/dev` directory. As an example, you could write PCM data directly to the 'device' `/dev/snd` (as long as there is a DAC present), which would then pass the data on to the DAC, so you can hear the sound. Settings such as IP forwarding in a Linux router can be enabled by writing a '1' to `/proc/sys/net/ipv4/ip_forward`.

This method of control has the advantage that it makes it easier to adapt the kernel. This can also be automated by incorporating the commands in (shell) scripts. The most popular shell in Linux is bash [5].

Why Linux?

Embedded Linux reduces the amount of code that needs to be written during the development of a new end product compared to the amount of code that would otherwise have to be written for each of the separate hardware devices. Embedded Linux combines all the individual device drivers such as those for the display, the TCP/IP stack and the audio driver into one block. Because of this you don't have to worry about writing (and debugging) stable drivers for these and you can concentrate on the 'real' work.

Another big advantage of the use of an open source operating system such as Embedded Linux is that you don't have to rely on a commercial firm for updates and patches. Updates are often very board-specific and are usually made available by the manufacturer of the board. Direct support for the Linux-in-a-Box board can be easily obtained (and free, too) from the manufacturer [1].

In cases where a manufacturer has very little involvement with the development of the system you often see that there are other developers having continued development for their own projects. You can also come across developers with different ideas about what the software was originally designed for, or its purpose. A good example of this can be found with the Embedded Linux BeagleBoard [6].

What's next?

In this article we've given you a small taster of Embedded Linux. The possibilities are almost endless because you have the freedom to adapt everything to your own needs. There is certainly no shortage of documentation; there is a vast amount available on the Internet. A good book can be just as useful when you're looking for the proverbial needle in a haystack. It is always possible that you'll come across some problems, but for most open source projects you should be able to find a forum. On these you often find people who had the same problems and who found the solutions to them. And finally, another site: 'Linux for Devices' [7] is a portal with news

Listing 1. The 'led_counter.sh' script

```
#!/bin/bash
#
# nanoLIAB led shell script
#
# This script writes values in binary to the
# four leds on the board with 1 second
# interval.

# The array of the possible values
VALUES=( 1 2 3 4 5 6 7 8 9 A B C D E F )

# Write every value in VALUES to the device
# with nanoctrl
for value in ${VALUES[*]}; do
    # Display written data and write to leds
    echo "Writing 0x$value to leds"
    nanoctrl -l $value

    # Wait one second
    sleep 1
done
```

on the latest Linux-on-devices. Here you can keep up to date on developments on devices that work with (Embedded) Linux.

(091034)

Internet Links

- [1] www.liab.dk
- [2] www.elinux.org
- [3] www.ubuntu.com
- [4] [http://en.wikipedia.org/wiki/Tar_\(file_format\)](http://en.wikipedia.org/wiki/Tar_(file_format))
- [5] <http://en.wikipedia.org/wiki/Bash>
- [6] www.beagleboard.org
- [7] www.linuxfordevices.com

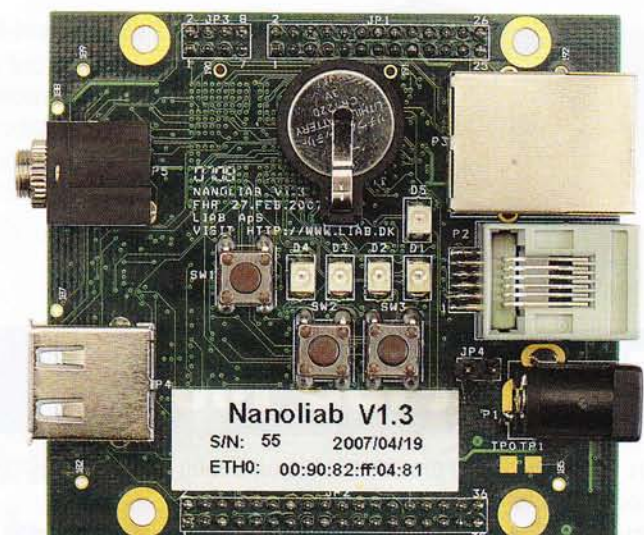

Developing and learning

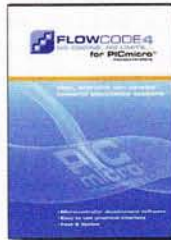
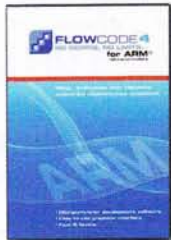
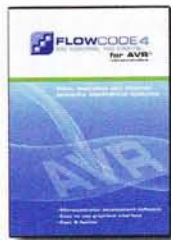

Flowcode 4 is one of the world's most advanced graphical programming languages for microcontrollers. The great advantage of Flowcode is that it allows those with little to no programming experience to create complex electronic systems in minutes.

www.elektor.com/flowcode

... for electronics

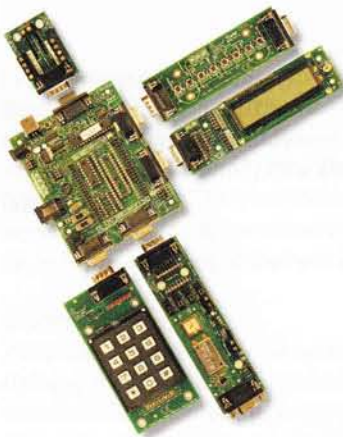

E-Blocks are small circuit boards each of which contains a block of electronics that you would typically find in an electronic or embedded system. There are more than 40 separate circuit boards in the range; from simple LED boards to more complex boards like device programmers, Bluetooth and TCP/IP. E-blocks can be snapped together to form a wide variety of systems that can be used for teaching/learning electronics and for the rapid prototyping of complex electronic systems. Separate ranges of complementary software, curriculum, sensors and applications information are available.

... for industrial control



MIAC (**M**atrix **I**ndustrial **A**utomotive **C**ontroller) is an industrial grade control unit which can be used to control a wide range of different electronic systems including sensing, monitoring and automotive. Internally the MIAC is powered by a powerful 18 series PICmicro device which connects directly to the USB port and can be programmed with Flowcode, C or assembly. Flowcode 4 is supplied with the unit. MIAC is supplied with an industrial standard CAN bus interface which allows MIACs to be networked together.

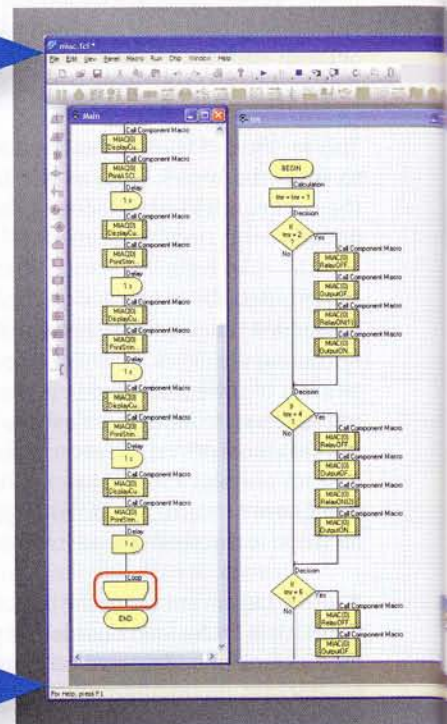

Flowkit ICD Tool

NEW

The new Flowkit tool provides In Circuit Debug (ICD) for a range of Flowcode applications for PIC and AVR projects:

- Start, stop, pause and step your Flowcode programs in real time
- Monitor state of variables in your program
- Alter variable values
- In circuit debug your Formula Flowcode, ECIO and MIAC projects



ng with Flowcode 4

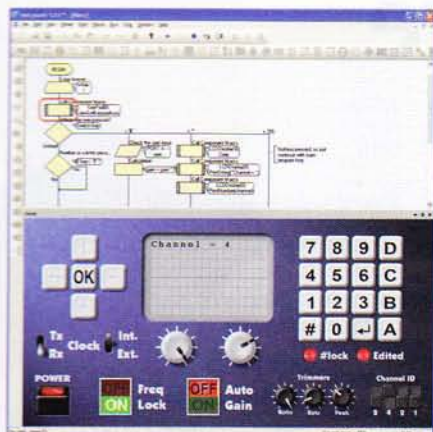

New features in Flowcode 4

Flowcode 4 is packed with new features that make development easier including:

- Panel Creator
- In Circuit Debug
- Virtual networks
- C Code customization
- Switch Icon
- Floating point
- Additional string functions
- Watchdog timer support
- New user interface
- New components
- Fast USB development

... for robotics

Formula Flowcode is a low cost robot vehicle which is used to teach and learn robotics, and to provide a platform for competing in robotics events. The specification of the Formula Flowcode buggy is high with direct USB programming, line following sensors, distance sensors, 8 onboard LEDs, sound sensor, speaker and an E-blocks expansion port. The buggy is suitable for a wide range of robotics exercises from simple line following through to complete maze solving. E-blocks expansion allows you to add displays, connection with Bluetooth or Zigbee, and GPS.

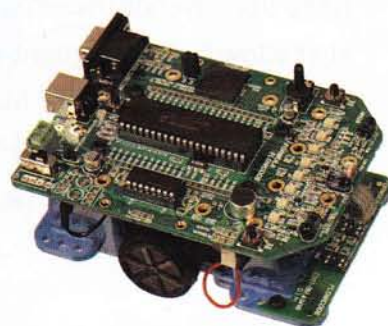

... for USB projects

ECIO devices are powerful USB programmable microcontrollers with either 28 or 40 pin standard DIL (0.6") footprints. They are based on the PIC 18 series and ARM 7 series microcontrollers. ECIO is perfect for student use at home, project work and building fully integrated embedded systems. ECIO can be programmed with Flowcode, C or Assembly and new USB routines in Flowcode allow ultra rapid development of USB projects including USB HID, USB slave, and USB serial bus (PIC only). ECIO can be incorporated into your own circuit boards to give your projects USB reprogrammability.

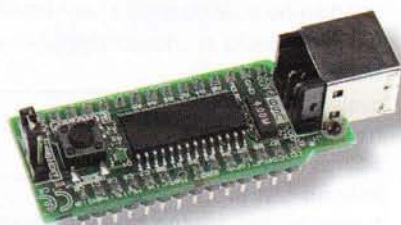

More information and products at:
www.elektor.com/eblocks

Reign with the Sceptre

A 32-bit ARM7 fast prototyping system

By Clemens Valens (Elektor France Editor)

This open-source & open-hardware project aims to be more than just a little board with a big microcontroller and a few useful peripherals — it seeks to be a fast prototyping system. To justify this title, in addition to a very useful little board, we also need user-friendly development tools and libraries that allow fast implementation of the board's peripherals. Ambitious? Maybe, but nothing should deter you from becoming Master of Embedded Systems Universe with the help of the Elektor Sceptre.

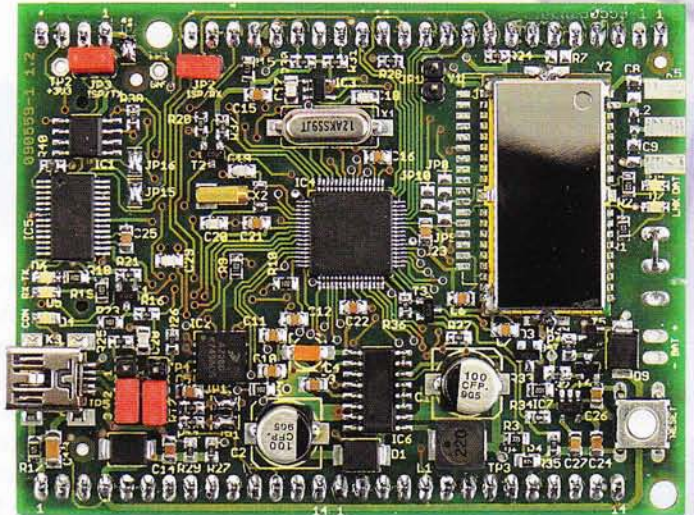

The aim of fast prototyping is to produce an operational prototype of an application in the shortest possible time. To achieve this, we need powerful, easy-to-use tools — especially when a microcontroller application is involved. The ideal is a simple assembly of a few intelligent building-blocks. Often, you need only a single version of a set-up, and would like to use the prototype as is. So you need to be able to treat these intelligent building-blocks as consumables.

Many commercially-available microcontroller development boards are not suitable for fast prototyping as they are too large, too fragile, or simply too expensive to be used only once. Usually, there is also a lack of software support for developing an application rapidly. One excellent example of a fast prototyping platform is Arduino^[1], which we tell you about from time to time. However, one of the drawbacks with Arduino is its low calculating power. So we almost always have to add an expansion board to be able to use it, as an Arduino board has no peripherals. It

was while contemplating these weaknesses that the idea for Sceptre was born. Here are the specifications collected thus far for a powerful fast prototyping platform:

- powerful microcontroller
- built-in useful peripherals
- easy to implement
- compact size
- cheap

available, but specification #3 rules out a lot of them. We ended up choosing the LPC2148 from NXP for the following reasons:

- Popular: easy to find, thanks to a big community of users.
- Available in an LQFP64 package:

Open mobile platform

Let's add a sixth point to the list:

- the project must be able to be built by an (experienced) amateur, which implies the use of readily-available components that are also easy to solder.

Let's start with the first specification: the brains of the project. The most powerful microcontrollers currently accessible to enthusiasts are 32-bit ones. Several are

- relatively easy to solder, even using DIY tools.
- In situ programmable via a simple serial port: doesn't need a special programmer.
- Powerful: 32-bit ARM7TDMI-S core, 512 KB flash memory, 40 KB RAM, lots of built-in peripherals, including USB 2.0 and a real-time clock.
- Easy to implement: the multi-platform open-source development tools are

Technical specifications

- 32-bit ARM7TDMI-S LPC2148 microcontroller, 512 KB flash, 40 KB RAM
- USB 2.0
- Bluetooth (Class 1 or 2)
- SD card reader
- Serial port via USB (e.g. for in situ programming)
- 3-axis accelerometer
- DS18B20 thermometer
- Real-time clock
- All microcontroller pins accessible
- Battery or USB port powering
- Li-ion battery charger
- Compact: 6 × 8 cm
- Open-source tools, software, and hardware
- Open-source extended library

available free on the Web, as are lots of libraries.

We could argue for ages about the peripherals that are 'useful' to have on the sort of board we're thinking of. After lengthy consideration, we've chosen the following (Figure 1):

- Bluetooth module: naturally, a wireless link (class 1 or 2, as you prefer) is obligatory these days.
- SD card reader: for storing data and programs.
- USB 2.0 (peripheral): since it's already included in the microcontroller...
- RS-232 serial port via USB: handy for in situ programming.
- 3-axis accelerometer: this'll let you do some super things.
- Thermometer: always comes in handy!
- Real-time clock: lots of applications need one.
- Li-ion battery charger: as the board's going to be small, it will be portable, so battery powering is a must.
- Expansion port: because you can't always plan for everything, all the microcontroller's pins will be accessible via terminal strips.

All this on a small board unfortunately rather conflicts with specification #6, as we are obliged to use SMD components and a rather dense, double-sided PCB. We have, however, taken the trouble to pick SMD components that are relatively easy to fit. As a result, the PSU / battery charger for example is more complicated than necessary. The only component that's not easy to fit yourself is the 3D accelerometer. We've not found this sort of component in an 'easy' package.

Since Sceptre is based on numerous open source code projects, it's only natural that this project too has an all-open structure. Hence the source codes and CAD files (Eagle) are available for free download from the Sceptre website [2]. So you can modify everything — you're the one in charge!

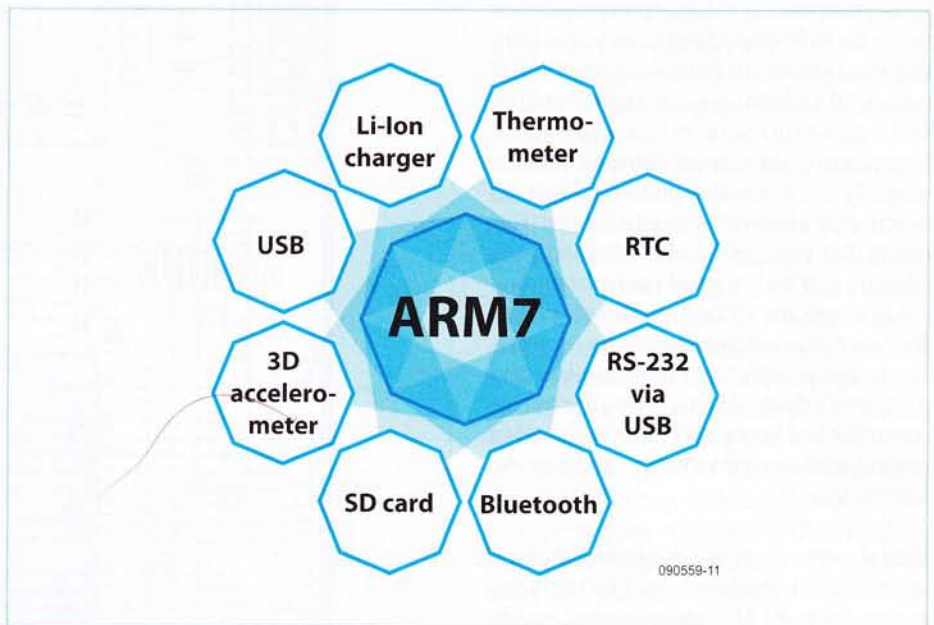

Figure 1. Sceptre block diagram.

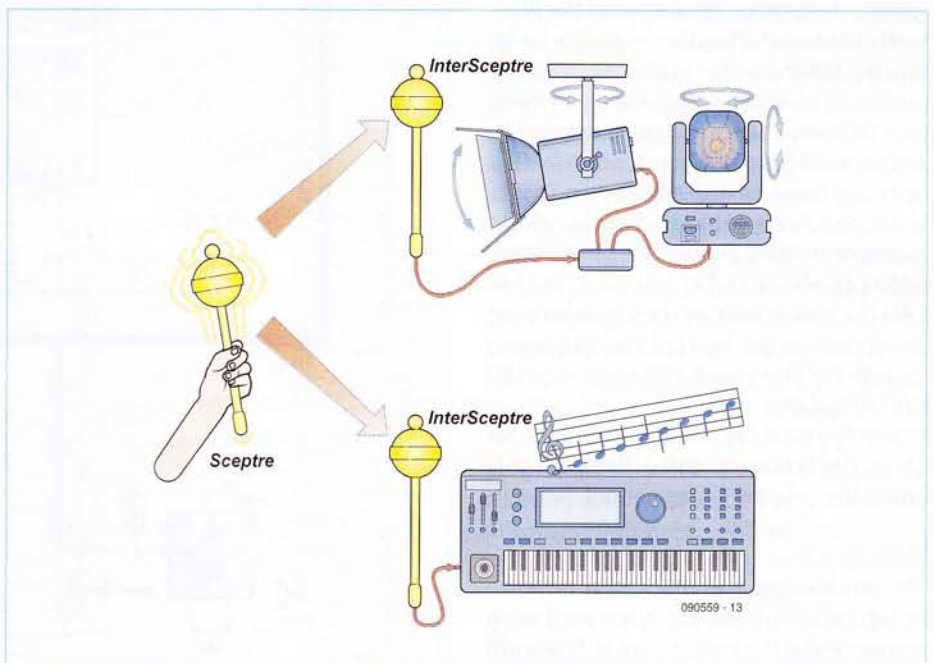

Figure 2. Here's one possible application for the Sceptre. The InterSceptres provide the interface between the Sceptre and any peripheral such as a synthesizer or a stepper motor.

Applications

Those familiar with Nintendo's Wii games console may have noticed the similarities between the Sceptre and the Wiimote, the remote control for the Wii. It's true (given that this is a totally open project, we won't be hiding anything from you — long live transparency!): both are portable and include Bluetooth, a 3-axis accelerometer, and a powerful micro. In fact, our original idea was to build a sort of Wiimote, and the name Sceptre was chosen to highlight its function as a powerful remote control (Figure 2). But you can do a lot more with the Sceptre, as it's a universal open platform. For example, the SD card reader lets you use the Sceptre as a stand-alone data recorder. The board already has a thermometer and a real-time clock. What's more, the microcontroller and board have been designed to minimize power consumption and prolong battery life.

Model enthusiasts will probably appreciate its Class 1 Bluetooth link (100 m range in free-field), its 3D accelerometer, and its pulse width modulation (PWM) capabilities, as it will be possible to use the Sceptre as the brain for remote-controlled devices or robots. To take full advantage of the Bluetooth, the board offers the possibility for fitting an SMA connector so you can connect a proper aerial. Provision has also been made for a little impedance matching network. As the board has a USB port (two, in fact!) it can easily interface with a computer. Thanks to the Sceptre's expansion ports, all the microcontroller's peripherals can be used: UART (2), SPI (2), I²C (2), MLI (6), CNA (14), CAN (1), USB. It will even be possible to use the Sceptre as the heart of a small computer with PS/2 keyboard, LCD screen, and SD card virtual disk drive.

In short, as we say when we're stuck for ideas: the Sceptre's applications are only limited by your own imagination!

Hardware

The circuit diagram of the Sceptre is shown in Figure 3. As there are a hundred or so components, the circuit may at first sight seem daunting, but looking closer, you'll see that there's nothing terribly complicated about it. So we're not going to go

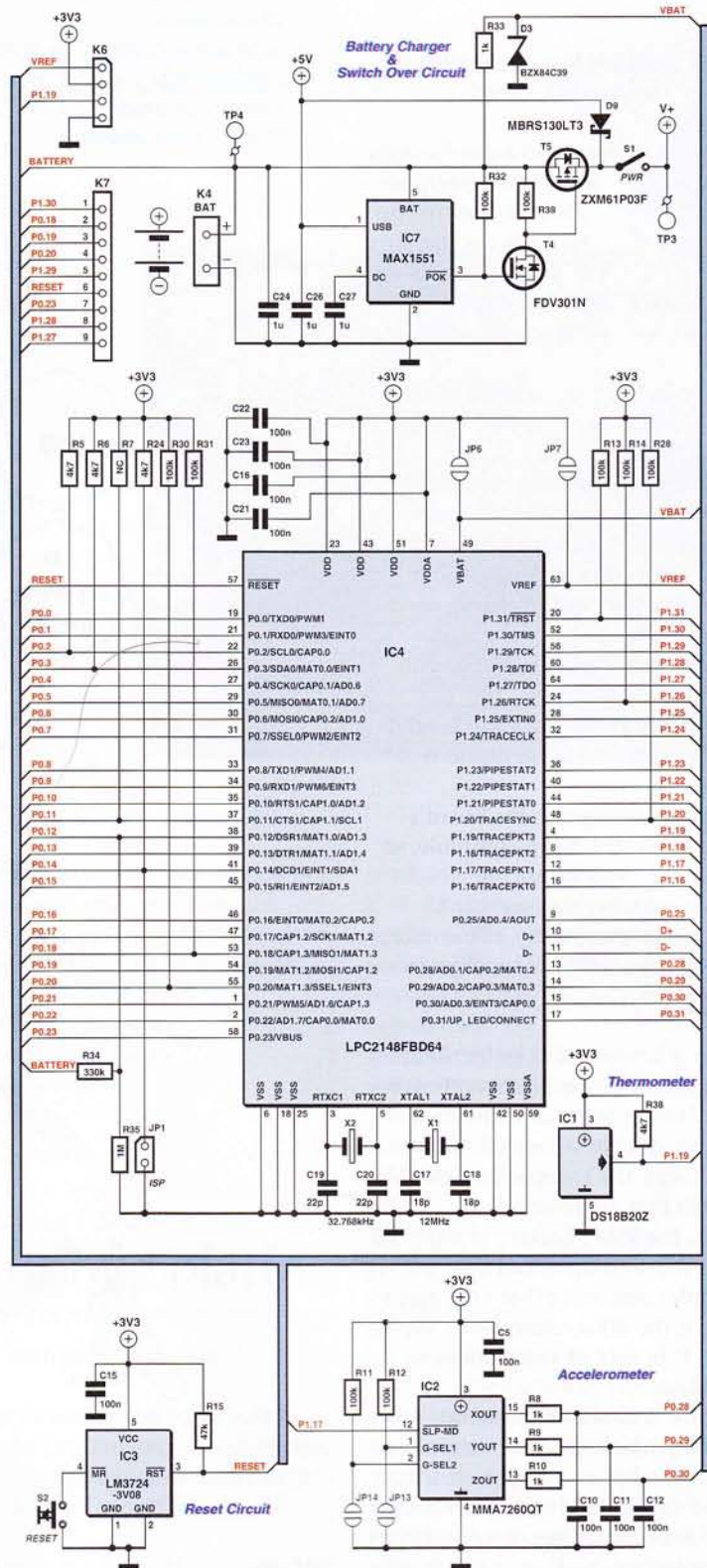
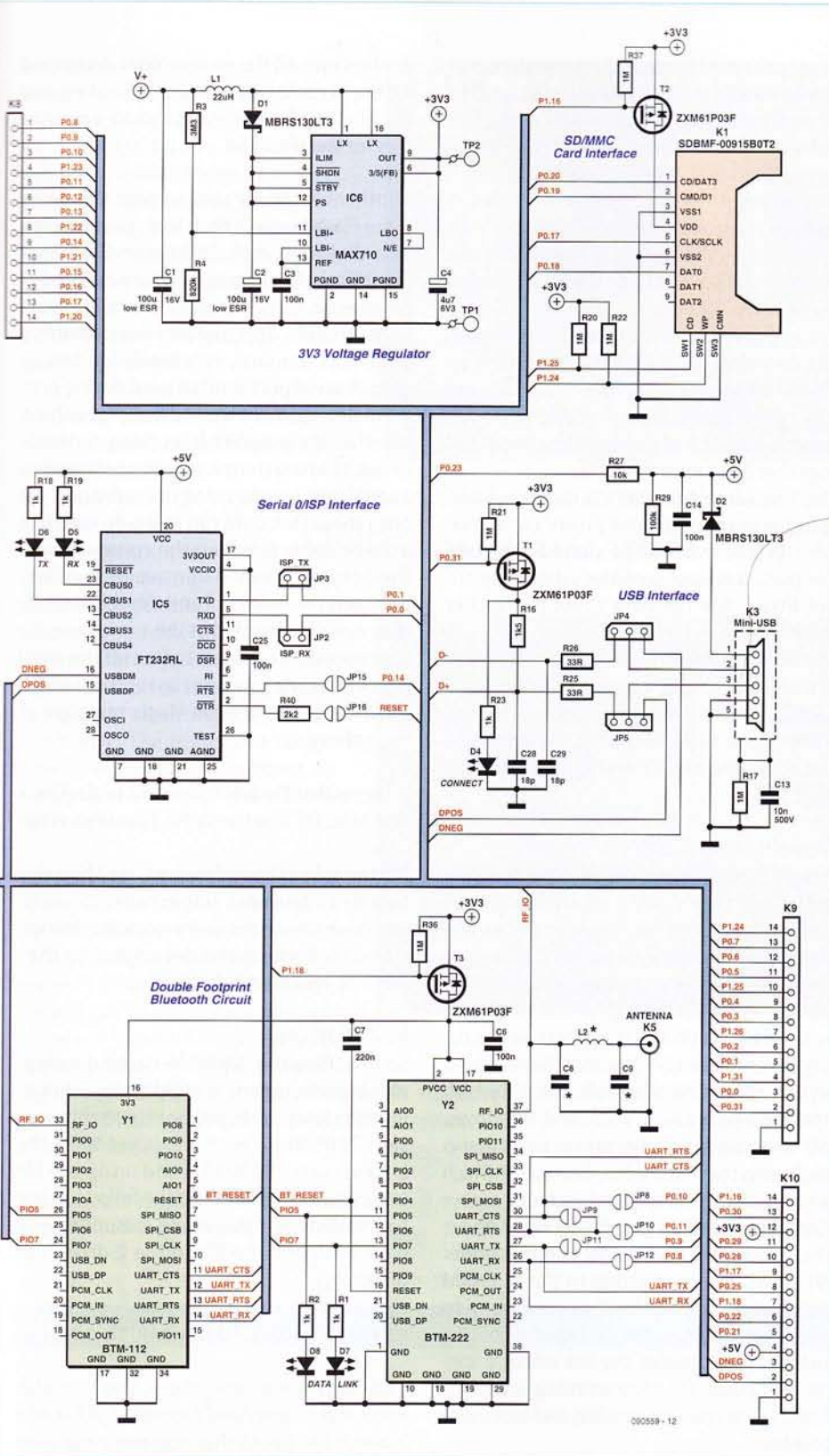

Figure 3. The full circuit diagram of the Sceptre. It's a bit big,



through it in detail, but confine ourselves to a few comments:

First, the power supply. The board can be powered from a battery or via the USB port. USB powering takes priority, and is also used for charging the battery. The MAX1551 IC is a Li-ion battery charger with just five pins. The device detects if a voltage is available on one of its two inputs (we're only using one of them).

In order to minimize the volts drop when the board is being powered from the battery, the circuit used to switch between the 5 V rails from the USB port and the battery (D9, T4 and T5) is a bit more complicated than the two diodes usually found in this type of circuit. Naturally, the aim is to make the battery last as long as possible. The voltage from the battery or USB port is then converted to 3.3 V by the MAX710. This operates down to 1.8 V, so we can discharge the battery quite a long way. Cheaper, ready-made PMIC (Power Management Integrated Circuit) devices do exist offering all the functions described above and more. But the problem is that these PMICs only exist in QFN packages, or worse still, BGA — in short, packages we have sought to avoid at all costs.

There are two USB port on the board, but only one socket. Two jumpers let you choose which of the two ports will be entitled to use the on-board socket. In the event that you need to use both ports at the same time, it's possible to connect a USB socket for IC5 to the expansion port K10. IC5 is provided first and foremost for programming the board via USB, i.e. during the development phase. Once the application is finished, it is possible to disconnect it and free up four I/Os. The IC is powered solely from the USB 5 V rail and so doesn't drain the battery power.

Solder bridges JP15 and JP16 can make programming a little more convenient by allowing automatic switching between the programming mode and the microcontroller's normal operating mode. Without these bridges, each time you want to program the board, you have to fit JP1, press the reset button, program the microcontroller, remove JP1, and press the reset button again, which can become a pain after a while.

owing to the number of components, but there's nothing terribly complicated about it.



Figure 4. Configuring Flash Magic. The communications parameters are the most important ones. For programming, the serial port speed must not be above 38,400 baud. For the terminal, you can choose a higher speed.

LED D4 is intended as an indicator that the microcontroller's USB port is connected, but there's nothing stopping you using it for something else. In this event, remember to remove R16 if the microcontroller's USB port has to operate at the same time. To save power, the SD card reader and the Bluetooth module are switched using transistors (T2 and T3 respectively).

The board has two positions for a Bluetooth module, one for a Class 1 module (BTM-222), the other for a Class 2 module (BTM-112). Once again, the reason is the board's power consumption. A Class 1 module (100 m, 300 ft) draws significantly more than a Class 2 module (10 m, 30 ft). The little 'π' network C8, L2, and C9 has



Figure 5. Options -> Advanced Options...: Checking this box enables Flash Magic to put the Sceptre in programming mode and reboot without your having to do anything.

been provided in case the impedance of the Bluetooth module's RF output needs to be matched to the aerial. In most cases, this network isn't required, and L2 can simply be replaced by a wire link or 0 Ω resistor. A 31 mm length of wire will do as an aerial, but it's possible to fit an edge-type SMA connector to the board. That way, you can screw a 'WiFi' aerial onto the board — now there's class for you!

The suggested Bluetooth modules require just two wires (RX and TX) for communicating with the microcontroller. The RTS and CTS signals are however available (well, you never know...) and they can be connected together if necessary via JP9.

The 3-axis accelerometer IC2 can be put into standby in order to limit power consumption. Its sensitivity can be altered using two jumpers. It is least sensitive when they are not fitted. See the data sheet for further details.

The thermometer only uses power when you actually talk to it. It's a good little device. Lastly, jumpers JP6 and JP7 let you choose the voltage sources for V_{batt} (required by the real-time clock) and V_{ref} (needed for the CNA).

Development environment

Programming a microcontroller requires tools, and that's often where things get complicated. Not for the Sceptre, as the development tools were part of the original specifications: they must be free and multi-platform. The advantage of the ARM core as used by Sceptre is that there are actually several free compilation chains based on GCC (GNU Compiler Collection^[3]) which operate under Linux, Mac, and Windows. We've opted for a collection of tools that is beginning to get a bit dated now, but which is really easy to install and includes everything you need to get going right away. The drawback is that it only operates under Windows. We're referring to the WinARM distribution^[4], a big file that you'll have to unzip after downloading it. This distribution includes the compiler, the link editor, a special text editor for programming, a tool for flashing the microcontroller, and lots more besides.

Of course, just because we happened to choose WinARM doesn't mean you have to

do the same. All the source codes developed for the Sceptre ought to compile using any C/C++ compiler that can produce executables for the LPC2148.

Another reason for staying with Windows is the Flash Magic^[5] flash tool. Even though WinARM does include its own flash tool (lpc21isp), Flash magic, which is free for private use, is user-friendly and helps avoid finger trouble. This tool also incorporates a serial port terminal, very handy for debugging. A serial port is often used during program development to send messages about whether the program is working correctly or not. Flashing the microcontroller requires a serial port too; by using the same port for both these tasks, we can make do with just a single cable between the computer and the Sceptre. Flash Magic avoids conflicts between the flash tool and the terminal, as they can't be enabled at the same time. So it's impossible to forget to free off the serial port each time you want to reprogram the microcontroller — Flash Magic takes care of everything.

It seems that Flash Magic works under Linux and MAC OS X in the WINE Windows emulator^[6].

For the sake of completeness, lpc21isp also includes a terminal, but in order to use it, you have to use the same communication speed for flashing and debugging, as they can't be specified individually.

Installation

So installing the WinARM-based development environment is child's play. Download the latest distribution^[4] (currently version 20060606, we haven't yet tried the beta version 20080331) and unzip the file onto your hard drive. Add the following line to the Windows pathname (assuming you have unzipped the file to the C drive root directory):

C:\WinARM\bin;C:\WinARM\utils\bin;

This step is not obligatory, you can also enter it at a command prompt or put it into a batch file (.bat) that you run each time you start a Sceptre programming session, like this:

```
set path = %path%;C:\WinARM\
bin;C:\WinARM\utils\bin
```

As WinARM knows everything you need, installation is now complete. You can test your installation by compiling one of the examples included in WinARM, which can be found here (for the LPC2148):

```
WinARM\examples\lpc213x_
lpc214x_examples\
```

For greater convenience, we recommend you also install Flash Magic (which replaces the LPC2000 Flash Utility, now obsolete). This application is constantly being updated to add new processors, so download and install the most recent version. Then configure the tool for Sceptre as shown in Figure 4, selecting the correct COM port. The options in Step 4 only slow programming down, so it's up to you to see if you want to use them or not.

You may not yet have installed the drivers for the Sceptre's serial port via USB. This port uses a standard FTDI chip, and you can find the drivers on [8] (VCP drivers). If you don't know if you've already got the drivers or not, connect the Sceptre up to your computer and your operating system (OS) will tell you. Modern OSs are able to find and install the correct driver all by themselves.

To check the communication between the Sceptre and the computer, it's worth try-

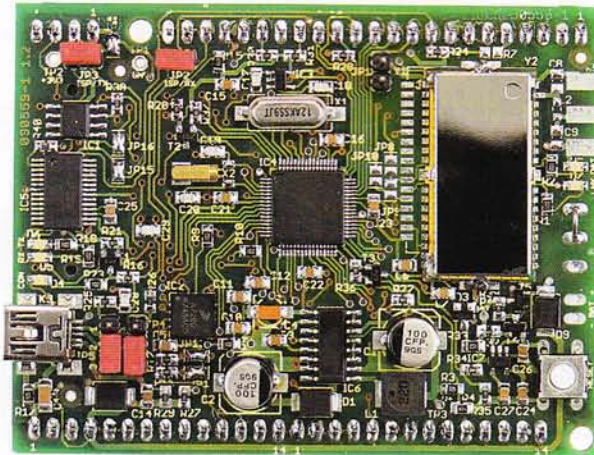

Using Sceptre, you're in control!

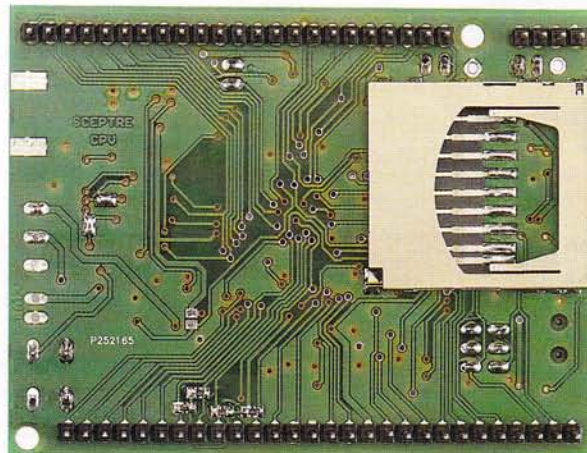

ing to detect the microcontroller. If the advanced options are correct (Figure 5), using Flash Magic this is achieved by the command "ISP -> Read Device Signature...". If everything is alright, you'll get the ID 0x0402FF25 and the bootloader ver-

sion 2.12. To do the same thing using the `lpc21isp`, you'll need to use the following command:

```
lpc21isp -detectonly -
control main.hex com4 38400
12000
```

You need to enter a HEX file, even if there isn't one. As identification, you should get:

```
Synchronizing. OK
Read bootcode version:
2.12.0
```

```
Read part ID:
LPC2148, 512
kiB ROM /
40 kiB SRAM
(67305253)
```

The last number is decimal for 0x0402FF25, the number found by Flash Magic.

To be continued...

Experienced readers will now be able to set about developing applications for the Sceptre. You can already download from [2] the first version of the C/C++ library we're in the process of developing. Although still far from finished, this library is going to contain functions for quickly developing an application based on the Sceptre.

Readers in less of a hurry may prefer to wait till next month to find out how to implement the Sceptre in detail. See you soon!

(090559-I)

Internet Links

[1] arduino.cc

[2] www.elektor.com/090559

[3] gcc.gnu.org

[4] www.siwawi.arubi.uni-kl.de/avr_projects/arm_projects/#winarm

[5] www.flashmagictool.com/

[6] www.winehq.org/

[7] www.pnotepad.org

[8] www.ftdichip.com

Modulo D

The world's smallest full-fledged stereo amplifier

By Folker Stange (Germany)



The external appearance of this small module with an LC display almost belies what it has inside: a complete stereo preamplifier and final amplifier with IR remote control, adjustable tone, volume and signal levels, and an output power of 2×20 W (Class D), all with a single 12-V supply voltage. This makes it perfect for use in a car, boat or motor home.

The required installation space is very small thanks to the extremely compact construction. This is primarily made possible by the very high efficiency of the PWM output stage (up to 94%), which reduces the complexity of the circuit and minimises the cooling footprint.

Weighing only 150 grams (5.3 oz.), this audio amplifier module essentially consists of two application-specific ICs and an inexpensive ATmega8 microcontroller, which handles the control functions of the Class D amplifier.

Class D module

The only thing small about this Class D amplifier module is its size. With a measured output power of 2×20 W, it features not only an amazing amount of power but also a rich set of features. With two sets of stereo inputs, configurable settings for volume, tone (treble and bass) and sensitivity, an infrared receiver for RC5 remote control, a backlit LC display, and down-

Features

- 2×20 W continuous output power with $4\text{-}\Omega$ loudspeakers
- remotely controlled bass, treble, volume, and preset signal level
- can be used with RC5-compatible remote control transmitters
- all functions digitally controlled by an ATmega8 microcontroller
- operating status displayed on a three-line LC display with 20 characters per line
- stereo input on Cinch sockets
- auxiliary input on a pin header (selectable under software control)
- display board with IR receiver can easily be fitted separately using a 10-way flat cable
- expansion port for extensions, such as an MP3 player or manual control
- open-source firmware enables individual extensions for specific application areas
- extremely compact because no heat sink is necessary
- dimensions (module without enclosure): $65 \times 40 \times 35$ mm (2.3 x 1.6 x 1.4 inch)
- efficiency up to 93%
- operating voltage range 11–14 V
- can be used with an onboard vehicle electrical network or an inexpensive 12-V power supply (4 A min.)

loadable firmware with source code and hex files, it can serve as a versatile basis for your own projects. The heart of the amplifier is a Maxim MAX9744, whose high efficiency has already been mentioned. It requires only a small number of external

components. The 'filterless' spread-spectrum modulation of this IC reduces or mitigates the effects of noise emissions from the loudspeaker cables (a typical problem with Class D amplifiers) thanks to the flatter and broader noise spectrum. The

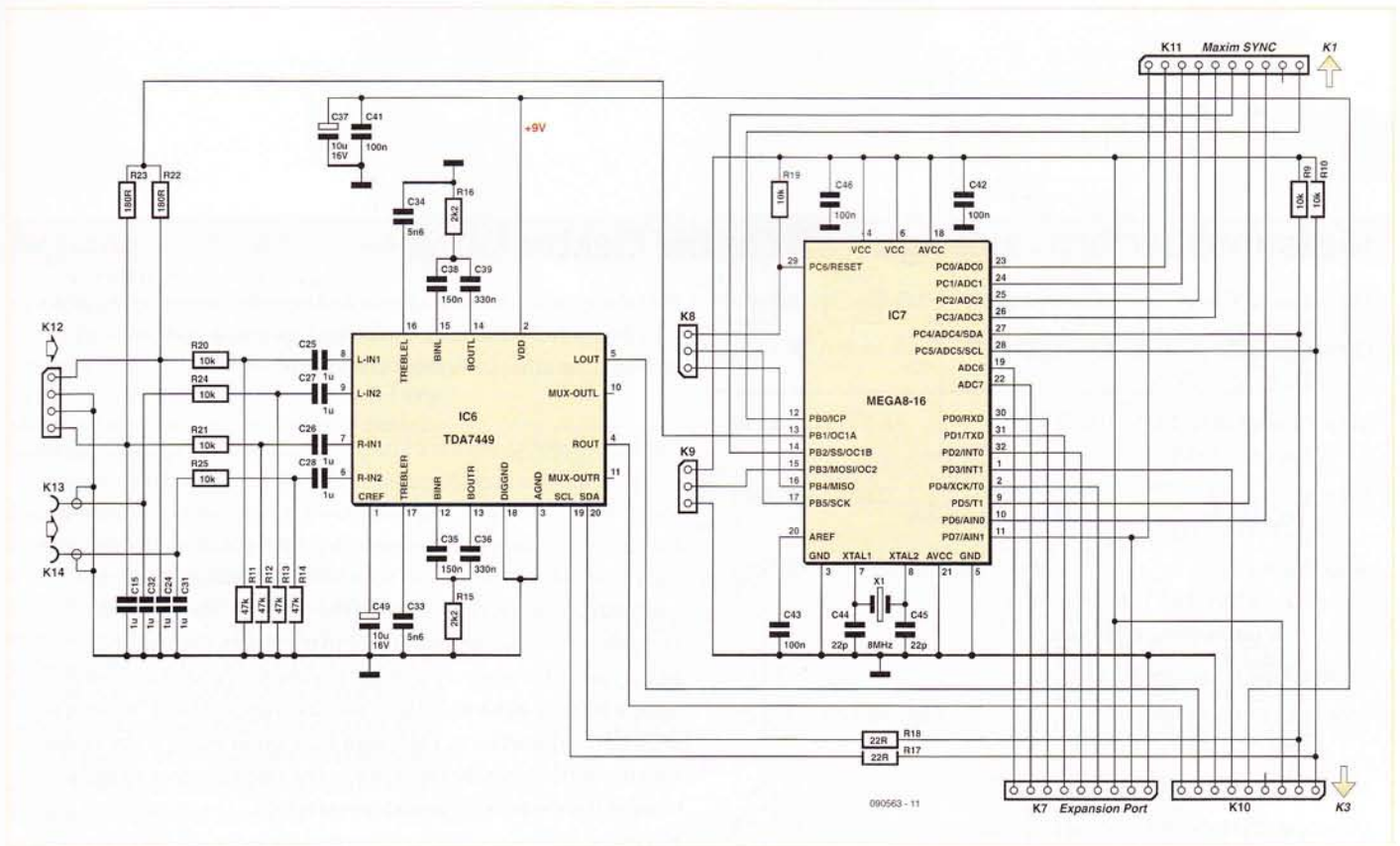

Figure 1. Schematic diagram of the microcontroller card, which in addition to the Atmel microcontroller holds the preamplifier IC with two selectable stereo inputs, which is controlled via the I²C interface.

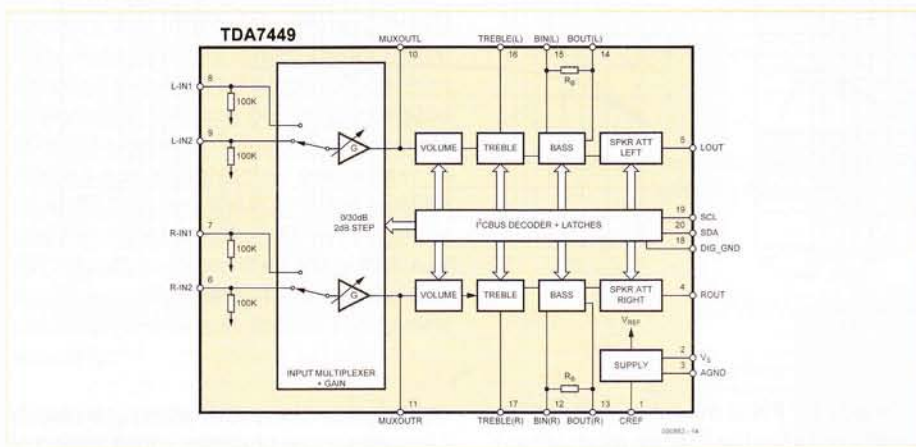

Figure 2. Block diagram of the STMicroelectronics TDA7449 digitally controlled preamplifier IC.

tiny MAX9744 has the potential to fundamentally change the process of DIY audio amplifier construction. The usual approach to building a final amplifier is to first find a suitable heat sink, which effectively determines the enclosure

dimensions. After this, cooling methods are devised, along with preventive measures in case the ambient temperature rises higher than expected. All this is unnecessary with the MAX9744, which can deliver a total output power of 44 W without any

need for a heat sink, despite its tiny 10-mm² QFN44 package size.

Trinity

The circuitry of the amplifier module is divided over three PCBs (Figure 6), which are arranged in a stack as shown in the photos. The amplifier input connectors are located on the rearmost PCB. As can be seen from the schematic diagram for this PCB (Figure 1), the Cinch sockets are connected to the preamplifier IC, a TDA7449 (IC6). As you can see from the block diagram of this IC in Figure 2 taken from its data sheet [1], it is a complete stereo preamplifier with two selectable inputs, input level control, volume and tone controls (treble and bass), and output level control. All of these functions are configured digitally via the I²C bus port (pins 18, 19 and 20). The input signal level (gain) control allows the sensitivity of the amplifier to be adjusted to match the signal source – including via the remote control interface with our design. The output level controls are used to adjust the stereo balance.

Measured performance figures from the Elektor lab

The following figures were measured using the Modulo D prototype:

Output power (8 Ω, 1 kHz, 10% THD)	10 W ($V_S = 12$ V)
13.5 W ($V_S = 14$ V)	
Output power (4 Ω, 1 kHz, 10% THD)	16.5 W ($V_S = 12$ V)
22 W ($V_S = 14$ V)	
THD+N	0.08% (8 Ω, 1 W)
0.12% (4 Ω, 1 W)	
Input sensitivity	35 mV (at maximum gain setting)
(8 Ω, 13.5 W, 10% THD, $V_S = 14$ V)	
1.12 V (at minimum gain setting)	
Lower cut-off frequency (-3 dB)	27 Hz
Tone adjustment range	Bass: +8.1 dB / -8.5 dB
Treble: +13.4 dB / -13.5 dB	
Efficiency (22 W / 4 Ω)	79 %
Quiescent current consumption	110 mA
Maximum current consumption	4 A at 2 × 22 W output power

The tone control characteristic curves show the frequency response with the control set to minimum, midrange and maximum, in each case with the other control set to midrange.

The second plot shows the distortion (THD) as a function of frequency. The distortion was measured at 1 W with a 4 Ω load (green curve) and an 8 Ω load (blue curve). The reason for the increased distortion level at low frequencies is not clear. According to the data sheet, the Class D amplifier IC is not the cause. We found that the distortion level in this region is dependent on the setting of the gain control. The distortion is slightly higher (0.2 to 0.3%) with the lowest gain setting and a 1-V input signal level. The plotted curve was measured using a 300-mV input signal level with a correspondingly higher gain setting. The distortion at 1 kHz with 1 W output power is the lowest with this setting, but the distortion in the low-frequency range is twice as high as with the lowest gain setting.

Ton Giesberts

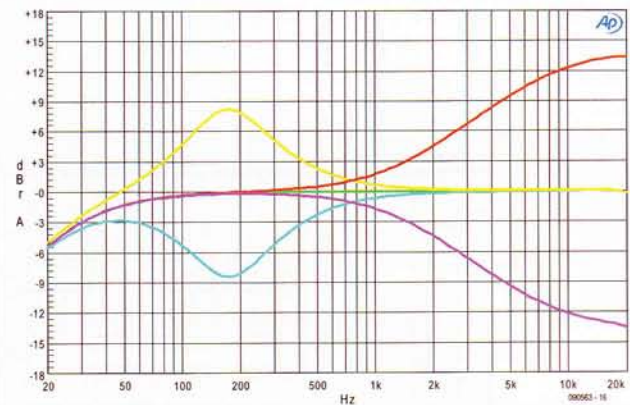
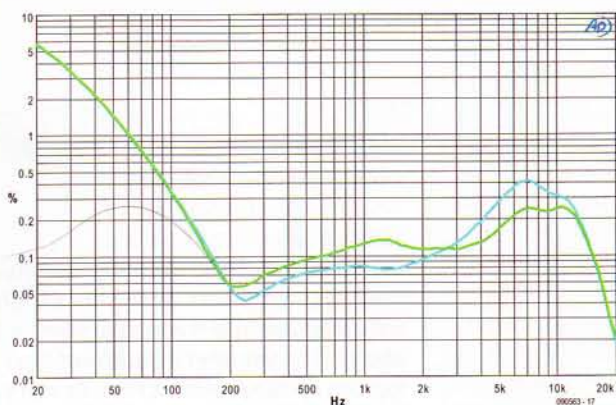

This PCB also holds the ATmega8 microcontroller, which handles all the control tasks of the amplifier module. It processes the signals from the IR receiver, converts them into corresponding I²C signals for the preamplifier, and provides the operational status indications on the LC display. A single signal line runs from the microcontroller (pin 11) via K11 and K1 to the PCB holding the final amplifier, whose schematic diagram is shown in **Figure 3**. There it is connected to the Sync input of the MAX9744, which selects the operat-

ing mode for PWM modulation (fixed frequency or spread-spectrum modulation). The external circuitry of the MAX9744 is just as straightforward as its block diagram (**Figure 4**). To enable this IC to handle the currents needed to supply such a high level of output power relative to its small dimensions, several leads of the IC are wired in parallel. High-capacitance electrolytic capacitors (1000 μF) next to the IC buffer power peaks. Wide PCB traces for the supply rails are necessary due to the high current levels. Even small deviations from the

manufacturer's specifications can easily cause enormous problems with a project of this sort. Consequently, the layout is suitably robust. The LC networks at the loudspeaker outputs of the IC are designed for operation in 'filterless Class D' mode. They provide adequate attenuation of harmonic emissions for speaker leads up to around 1 metre (3 ft.) in length. For even stronger attenuation or operation in fixed-frequency PWM mode, you can take the values of the filter components from a table in the IC data sheet [2].

The middle PCB also holds the power supply. The external supply voltage connected to K4, with a range of 11 to 14 V, is reduced to 9 V for the TDA7449 by IC5 and further reduced by IC3 to 3.3 V for the input stages of the MAX9744 and the ATmega8. D1 provides protection against reverse polarity and overvoltage.

This leaves the circuitry on the front PCB (Figure 5), which holds the LC display and the IR receiver. They operate from a 5-V supply voltage provided by an on-board voltage regulator (IC1). The voltage regulator receives its input voltage (9 V) from the underlying final amplifier board via K15. This voltage is also connected via resistor R5 to anode pin A1 of the backlight LEDs, which are wired in series via pins A2 and C1. The backlight is switched on or off by T1, which is driven by the microcontroller. For this purpose, R6 is connected to pin 14 of IC7 via K15, K2, K1 and K11. The output signal of the IR receiver also reaches the microcontroller via the same series of connectors.

Construction

DIY construction projects with SMD components are inherently more difficult than projects using leaded components. Although it doesn't take long to learn how to work with SMD components, fitting the MAX9744 forms a challenge even for experienced hot-air soldering specialists. To solve this problem, the PCBs in the parts kit available from the Elektor Shop [3] have the SMD components prefitted and tested. As a result, assembly is limited to fitting the conventional components and the mechanical assembly.

The display board snaps onto standoffs fitted to the final amplifier board. If necessary, the display board with the IR receiver can be fitted separately from the rest of the module, connected by a flat cable with a length up to 80 mm (3.1 in.). The final amplifier and microcontroller boards are joined by socket headers and pins (see Figures 7 and 8). Matching 10-way socket headers are located on the Class D amplifier board and the microcontroller board. To link them together, extract the pins from a 20-way pin header and plug them into the socket head-

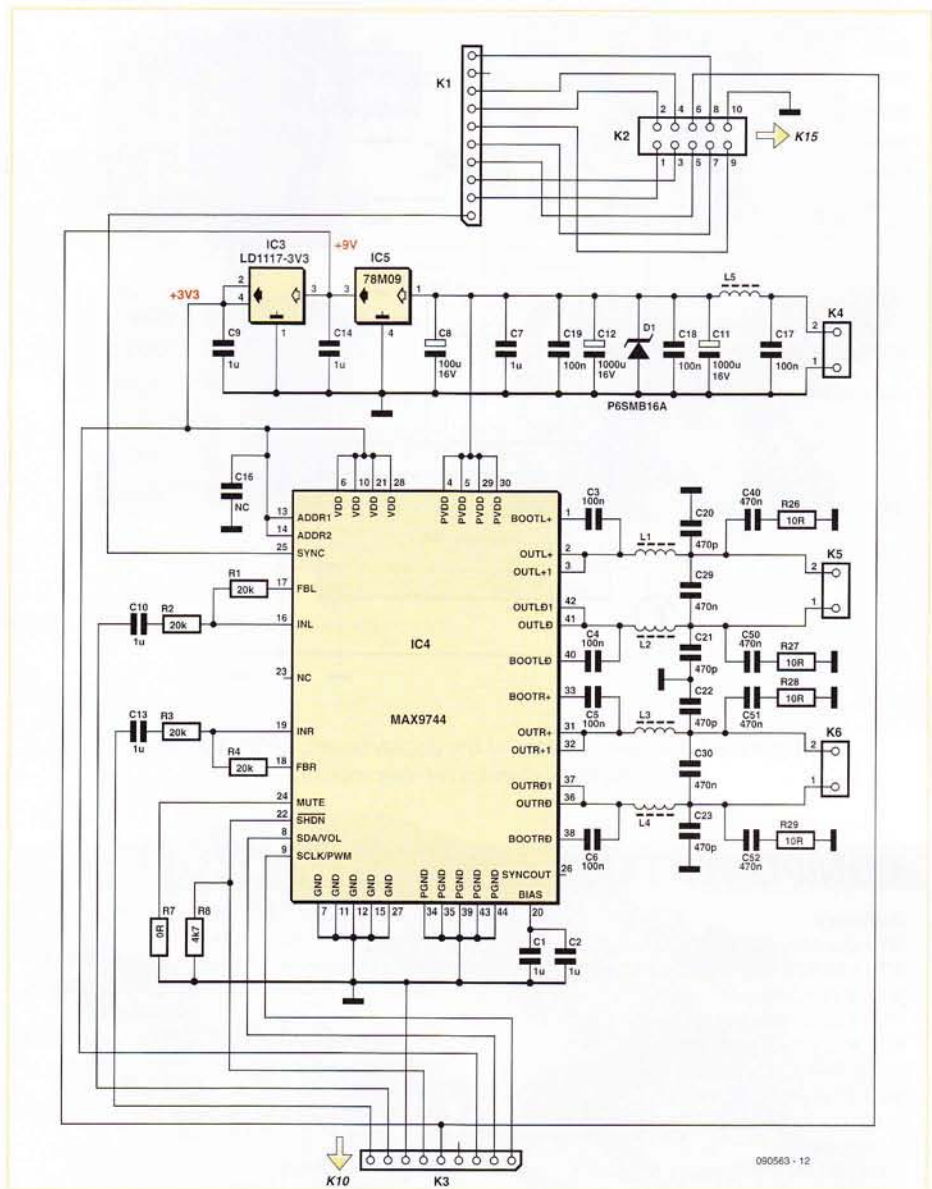

Figure 3. Schematic diagram of the Class D power amplifier using the MAX9744, which is fitted on the middle PCB of the amplifier module.

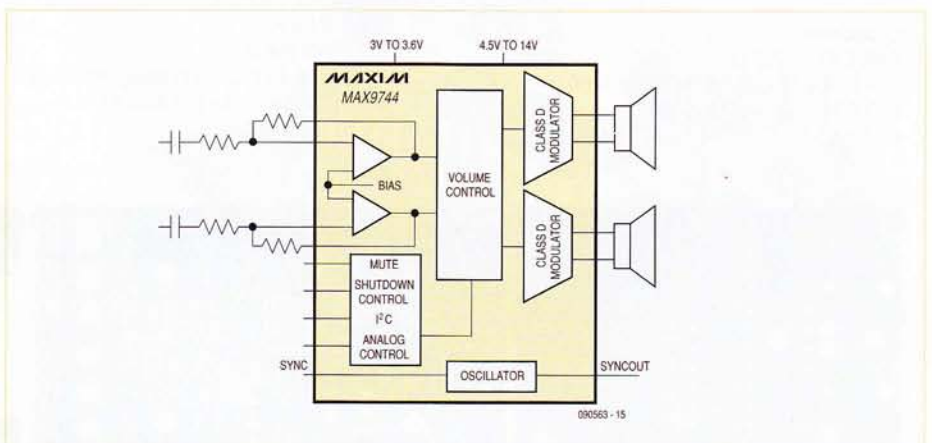

Figure 4. Block diagram of the MAX9744. The PWM operating mode is selected by the logic level on the Sync pin.

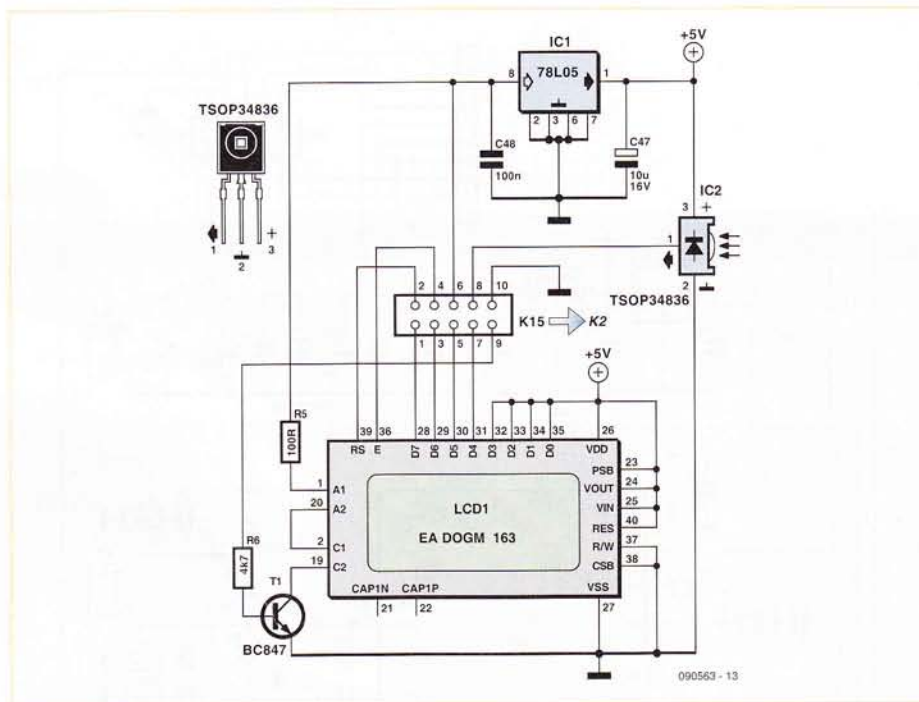

Figure 5. Schematic diagram of the display board, which also holds the IR receiver for remote control.

ers. This arrangement provides a secure connection between the boards, along with the right spacing. A standard audio input can be connected to the Cinch sockets, while the power source and loudspeaker leads can be secured to the generously dimensioned terminal blocks.

On the rear side of the microcontroller board, connectors for the expansion port (K7), the programming interface (K8 and K9), and the second stereo input (K12) can be fitted as necessary using the optional pin or socket headers. The expansion port (K7) can be used to add buttons for volume control, muting, and tone control (bass and treble), although this has not yet been implemented in the software.

COMPONENT LIST

Resistors

- R7 = 0Ω (SMD0603)
- R26, R27, R28, R29 = 10Ω (SMD0603)
- R17, R18 = 22Ω (SMD0603)
- R5 = 100Ω (SMD0603)
- R22, R23 = 180Ω (SMD0603)
- R15, R16 = 2.2kΩ (SMD0603)
- R6, R8 = 4.7kΩ (SMD0603)
- R9, R10, R19, R20, R21, R22, R24, R25 = 10kΩ (SMD0603)
- R1, R2, R3, R4 = 20kΩ (SMD0603)
- R11, R12, R13, R14 = 47kΩ (SMD0603)

Inductors

- L1, L2, L3, L4, L5 = VHF choke (6-hole ferrite bead)

Capacitors

- C44, C45 = 22pF (SMD0603)
- C20, C21, C22, C23 = 470pF (SMD0603)
- C33, C34 = 5.6nF (SMD0603)
- C3, C4, C5, C6, C17, C18, C19, C41, C42, C43,

- C46, C48 = 100nF (SMD0603)
- C35, C38 = 150nF (SMD0603)
- C36, C39 = 330nF (SMD0603)
- C29, C30, C40, C50, C51, C52 = 470nF (0603)
- C1, C2, C7, C9, C10, C13, C14, C15, C24, C25, C26, C27, C28, C31, C32 = 1μF (SMD0603)
- C37, C47, C49 = 10μF 16V (SMD tantalum case style B)
- C8 = 100μF 16V radial
- C11, C12 = 1000μF 16V radial

Semiconductors

- D1 = P6SMB16A (SMB)
- T1 = BC847 (SOT23)
- IC1 = 78L05 (SO8)
- IC2 = TSOP34836
- IC3 = LD1117-3V3 (SMD SOT223)
- IC4 = MAX9744 (MLF44)
- IC5 = 78M09 (DPAK)
- IC6 = TDA7449 (DIL20)
- IC7 = ATMEGA8-16 (TQFP32) (programmed)
- X1 = 8MHz quartz crystal (HC49U-V)

Miscellaneous

- LCD1 = EA DOGM 163 with backlight
- K1, K3, K10, K11 = 10-pin receptacle, straight, lead pitch 2.54mm (0.1"), h = 8.5mm
- K2 = 10-way flatcable, l = 140mm (5.5")
- K4, K5, K6 = clamp connector SPRINGCON 6-way lead pitch 5.0mm (0.2")
- K7 = expansion port (optional)
- K8, K9 = ISP Programming connector for Mega8, 6-pin (2x3) (optional)
- K13, K14 = Cinch socket, PCB mount, lead pitch 7.5mm (0.3")
- 4 plastic PCB standoffs, l = 4.8mm (0.18")
- 20-pin pinheader

Kit of parts with SMD prestuffed boards and all parts, Elektor Shop # 090563-71, see www.elektor.com/090563

PCB design (.pdf); free download from www.elektor.com/090563

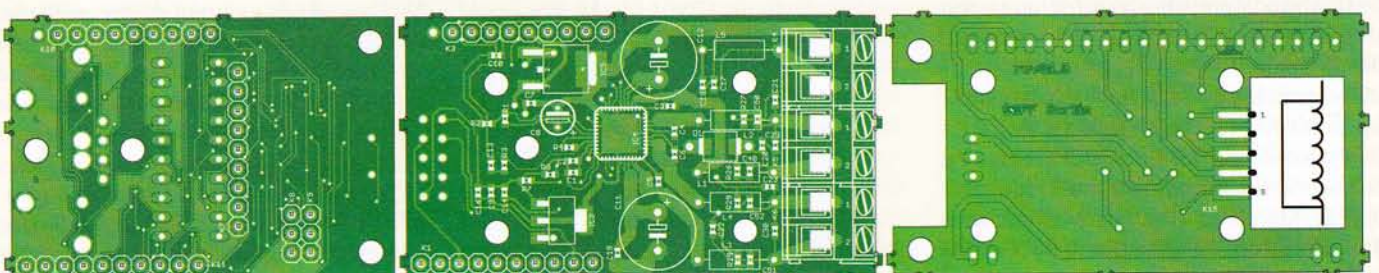

Figure 6. The three PCBs assembled in a stack: display board, final amplifier board and microcontroller board.

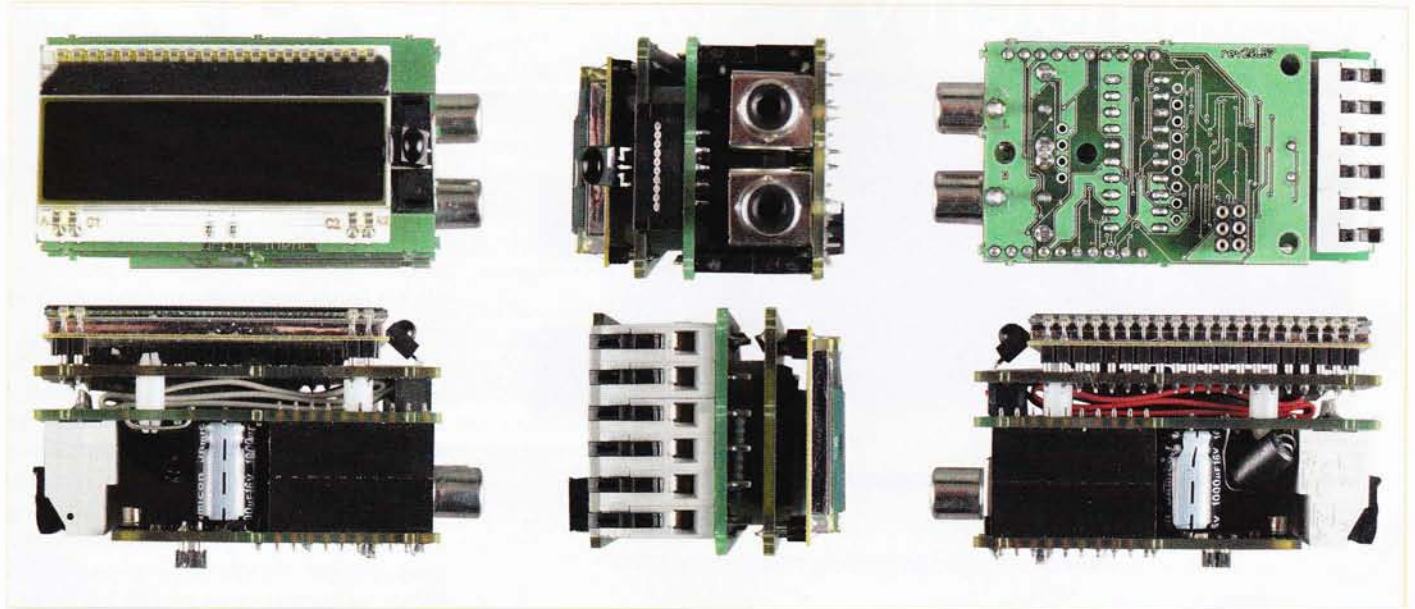

Figure 7. The Modulo D from various angles.

Software

The software for the ATmega was developed using WinAVR GCC and is available for download as commented source code, so you can adapt the firmware to suit your personal wishes and requirements. The compiled software (hex file) is available for download from the Elektor website [3] and the author's website [4] in two versions according to the desired operating mode of the MAX9744. You should normally use the hex file `ClassDV01.00Filterless.hex`, which configures the amplifier IC to operate with spread-spectrum modulation of the PWM signal. The initialisation routine `max9744init(MAX9744_FILTERLESS)` is called to initialise this operating mode.

For operation in PWM output mode with fixed-frequency operation, `main.c` calls the MAX9744 initialisation routine `max9744init(MAX9744_PWM)`. The downloadable hex file for this operating mode is called `ClassDV01.00PWM.hex`. If you use this version of the firmware, you must also fit the PCB with loudspeaker output filter components having the values specified for this operating mode on the IC data sheet. The hex file can be loaded directly into the microcontroller using a programmer, such as the one described in [5]. A screen dump included in the zipped download file shows the essential fuse settings for this. The microcontroller in the parts kit is prefitted and pre-programmed (using `ClassDV01.00Filterless.hex`). The programmed ATmega8 initialises the MAX9744 and the TDA7449, processes the received

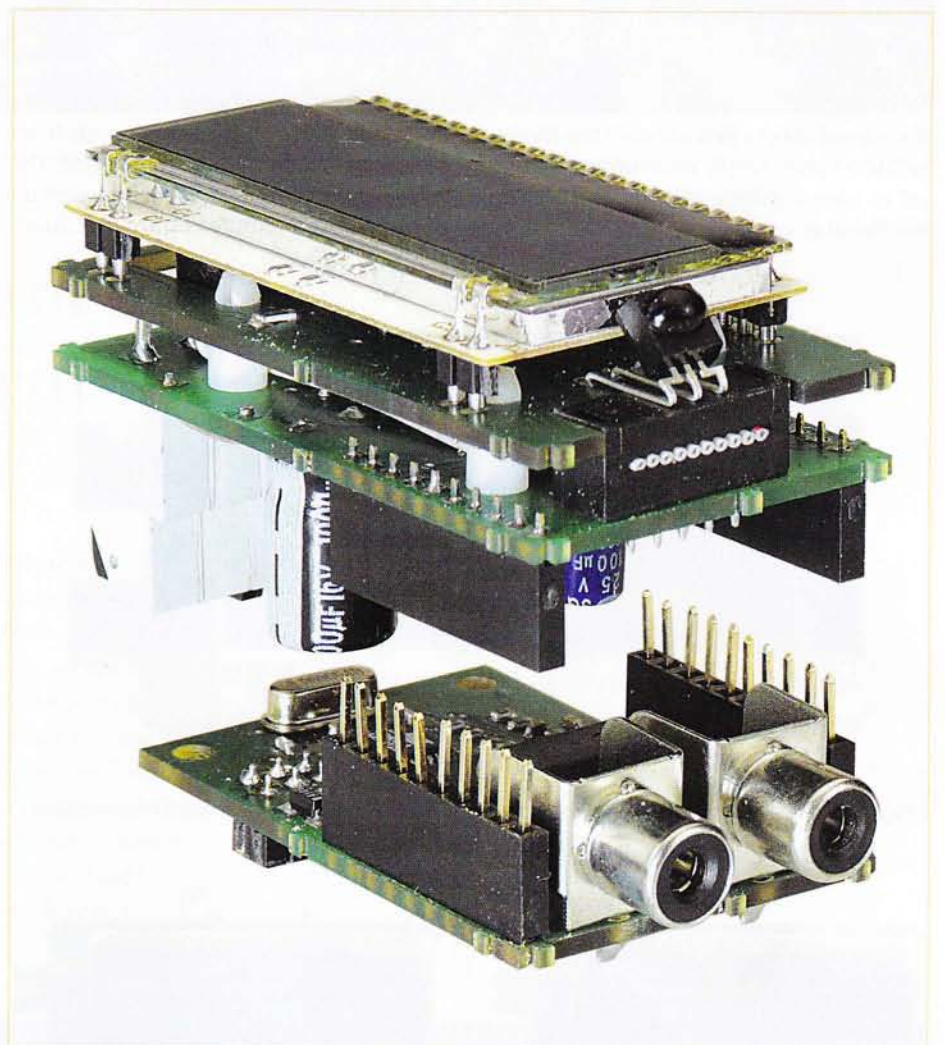

Figure 8. The final amplifier and microcontroller boards are joined by socket headers and pins.



Figure 9. This welcome message appears after the module is switched on.

IR commands, and controls the LC display. The software responds to RC5 remote control signals. The relationship between RC5 device addresses and RC5 commands is defined in main.h.

Testing and operation

It's a good idea to first connect the Modulo D to a power supply with current limiting set to approximately 200 mA, and with no loudspeaker connected. The current con-

sumption under these conditions should be around 120 mA. The display should first show the welcome message (Figure 9), followed around 5 seconds later by the volume setting (Figure 10).

After this you can quickly check whether the module responds to commands from an RC5-compatible remote control unit. The following button arrangement is present on a universal RC5 remote control unit: loud-



Figure 10. The volume setting is shown around five seconds after the welcome message. Other settings are shown below.



ness = Volume + and -, bass = 1 and 4, treble = 3 and 6, and gain = Fast Forward and Rewind.

If you do not have a suitable remote control unit available, you can still check out the amplifier module since the volume is set by default to around 35% instead of zero. If you connect a loudspeaker, you should certainly be able to hear something after connecting a line-level signal to the Cinch input. When connecting the loudspeaker, pay attention to the recommended maximum length of the loudspeaker cable (approximately 1 metre or 3 feet with the standard output filter; see also the MAX9744 data sheet).

As can be seen from the performance figures measured in the Elektor lab, the maximum rated power of 2 x 22 W is only possible with 4-Ω loudspeakers and a 14-V supply voltage. This can be obtained from a well-charged 12-V car battery or a 14-V power supply with a rated current capacity of 5 A. A 12-V power supply rated at 4 A is sufficient for a slightly lower power level.

The individual output stages of the MAX9744 operate in bridge configuration, so it is not possible to connect a loudspeaker between the R and L outputs to obtain twice as much power in monophonic mode.

The compact construction of this module allows it to be used in applications that are otherwise difficult to handle, such as in models, iPod stations, or a portable ghetto blaster with a gel-cell battery. Other options include using the expansion port to integrate an MP3 player or other signal source. With this arrangement, there's nothing stopping you from enjoying your personal MP3 collection at full blast.

(090563)

Internet Links

- [1] www.st.com/stonline/products/literature/ds/6317.pdf
- [2] <http://datasheets.maxim-ic.com/en/ds/MAX9744.pdf>
- [3] www.elektor.com/090563
- [4] www.stange-distribution.de
- [5] www.elektor.com/080083

XBee RF Modules

The **Digi XBee 802.15.4 modules** are the easiest-to-use, most reliable and cost-effective RF devices we've experienced. XBee modules provide two friendly modes of communication – a simple serial method of transmit/receive or a framed mode providing advanced features. XBees are ready to use out of the package, or they can be configured through the X-CTU utility or from your microcontroller. These modules can communicate point to point, from one point to a PC, or in a mesh network.



Digi XBee 802.15.4 modules

Power Lvl.	2 mW	2 mW	60 mW	60 mW
Antenna	Chip	Wire	Chip	Wire
Stock Code	#32404	#32405	#32406	#32407

PARALLAX

www.parallax.com

Friendly microcontrollers, legendary resources.™

Milford Instruments
www.milinst.com

Spinvent
www.spinvent.co.uk

PIC Cookbook for Virtual Instrumentation

➔ Several case studies included

The software simulation of gauges, control-knobs, meters and indicators which behave just like real hardware components on a PC's screen is known as virtual instrumentation. In this book, the Delphi program is used to create these mimics and PIC based external sensors are connected via a USB/RS232 converter communication link to a PC. Several case studies of virtual instruments are detailed including a compass, an oscilloscope, a digital and analogue thermometer, a FFT-based Frequency analyser, a joystick, mouse-control panels and virtual displays for cars and aircraft. Full source code examples are provided both for several different PIC's, both in assembler and C, together with the Pascal code for the Delphi programs which use different 3rd party Delphi virtual components.

elektor

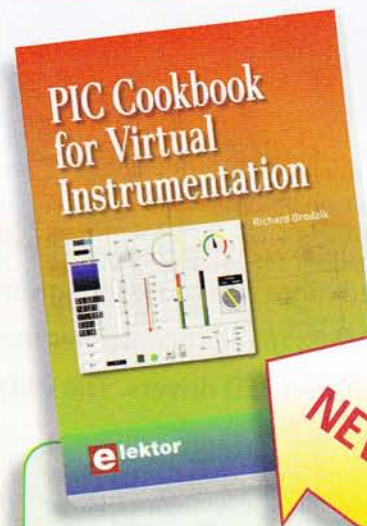

NEW

264 pages • ISBN 978-0-905705-84-2
£29.50 • US \$47.60

Elektor
Regus Brentford
1000 Great West Road
Brentford TW8 9HH
United Kingdom
Tel. +44 20 8261 4509

Further information and ordering at www.elektor.com/shop

LED Mixer with DMX Interface

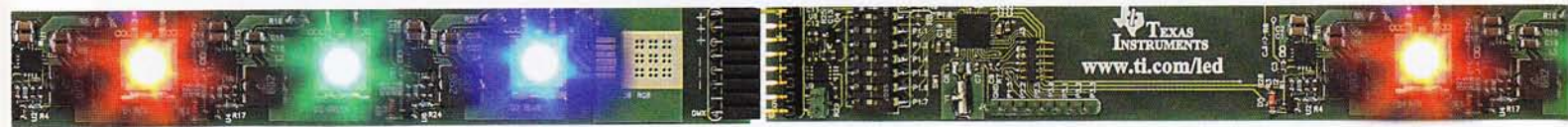

Three-channel DMX512-A receiver

By Dirk Gehrke and Walter Nitzold (Germany)

The DMX512-A system has long since become established in the stage lighting world. This standard is also being used more and more for lighting systems in buildings. The DMX LED lamp controller described here uses a TI MSP430 microcontroller to support DMX bus communication and generate PWM control signals for three power LED drivers. The DMX address can be set using DIP switches.

DMX512, which is also known as DMX or DMX512/1990, is a digital control protocol. It defines a serial data communication interface between controllers, lighting equipment and lighting accessories. DMX is based on the RS485 interface, which is commonly used in the industrial world and provides high noise immunity thanks to its differential data transmission mode. This interface can be used to connect a controller to one or more receivers, with practical upper limit of 455 m (1,500 ft) for the bus length, although the theoretical upper limit is 1 km (3,000 ft). The data rate is typically 250 kbit/s, with data being transferred in packets having a maximum of size of 513

bytes. This combination of data rate and packet size allows a repetition rate of 44 Hz with the largest packet size. As suggested by the name of the standard, up to 512 channels can be controlled individually, with each channel having a resolution of 8 bits. A maximum of 32 receivers can be connected in series in a single segment (daisy chain configuration). Repeaters must be connected between the segments if it is necessary to implement a configuration with more than 32 receivers. Each daisy-chain segment must be terminated by a 120- Ω resistor to avoid signal reflections. There are certain recommendations regarding the cabling to be used, although they are not always fol-

lowed in practice. The cables are connected to the equipment or interconnected by 5-way or 3-way XLR connectors. In contrast to audio equipment used in stage setups, the transmitter of a DMX system is fitted with a female XLR connector and the receivers are fitted with male XLR connectors.

LED wallwasher

A wallwasher is a strip light that illuminates a wall from below or above. In the project described here, the strip light consists of one or more narrow PCBs fitted with three 350-mA power LEDs. Several of these PCBs can be connected in series.

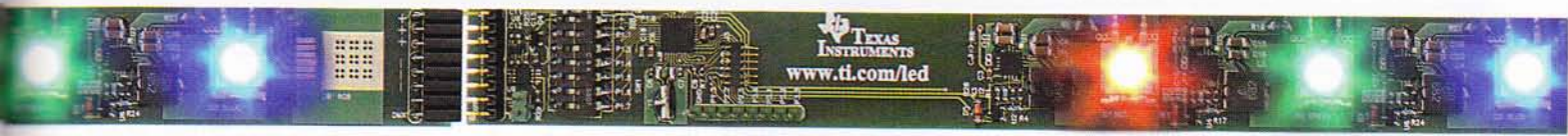

For this application, we have designed a three-channel DMX512-A receiver that processes the DMX512-A signal and compares it with an address set by a DIP switch. The receiver generates three 8-bit PWM signals that control constant-current driver stages.

As can be seen from the block diagram in **Figure 1**, the key component here is an MSP430 microcontroller, which receives a logic-level signal via an RS485 receiver IC. As already mentioned, the specification says that 5-way XLR connectors should be used by preference, but 3-way connectors are most often used in practice. Consequently, the adapter board for connecting the DMX cable (see the schematic diagram in **Figure 2**) is designed for 3-way XLR connectors (male and female).

Operating power is provided by a standard AC power adapter, which supplies 12 VDC at 1 A and is connected to J1 (DC power socket) on the adapter board. All three constant-current sources on the main board (see the schematic diagram in **Figure 3**) operate directly from this power source. Linear voltage regulator U8 (a TPS71550) provides a 5-V supply voltage for the RS485 IC (U9).

Table 1.
JTAG to DMX board adapter pinout

MSP430 JTAG connector pins	DMX512-A receiver board connector pins
NC	1
9	2
1	3
7	4
4	5
NC	6

NC = not connected

A series resistor (R25) and Zener diode (D4) reduce the 5-V supply voltage to 3.3 V for the MSP430F2274.

MSP430 circuitry

The 3.3-V supply voltage is connected to the AVcc and DVcc pins, with decoupling capacitors wired between these pins and ground. A pull-up resistor on the Reset pin or a Reset signal on the programming adapter Reset lead ensures controlled start-up in stand-alone or programming mode.

Spare port lines for potential extensions are fed out to pin headers J3 and J4. This gives the user access to an additional communication module (UC1), three analogue to digital converter inputs (A0, A1 and A2), or optionally eight parallel I/O port pins. Due to the narrow PCB shape, the Spy-by-Wire interface was chosen for device programming. This interface needs only a small number of lines, while still providing full programming and debug capability. As a result, we managed to achieve desired slender form factor for fitting to an aluminium profile and managed to do without a 14-way JTAG connector.

However, this means that you will have to assemble an adapter for connection between a 14-way JTAG connector and a 6-way Mill-Max connector for on-board board programming. The pin assignments of this adapter are listed in **Table 1**.

A means for assigning a specific DMX frame address to the board (receiver) is necessary. This takes the form of a DIP switch fitted on the board, which allows the address to be set using binary coding. Constant current sources U1, U5 and U7 can be enabled or disabled by the Enable signal from

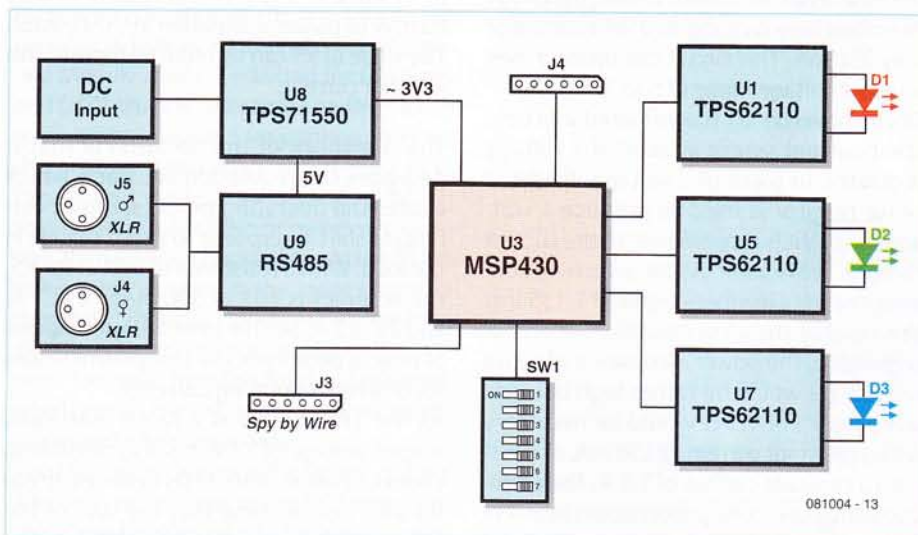

Figure 1. Block diagram of the three-channel DMX receiver and LED driver.

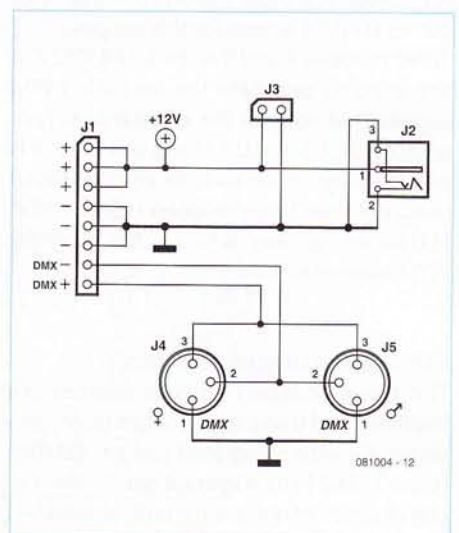

Figure 2. Schematic diagram of the adapter board for the DMX receiver and AC powerline adapter cable connections.

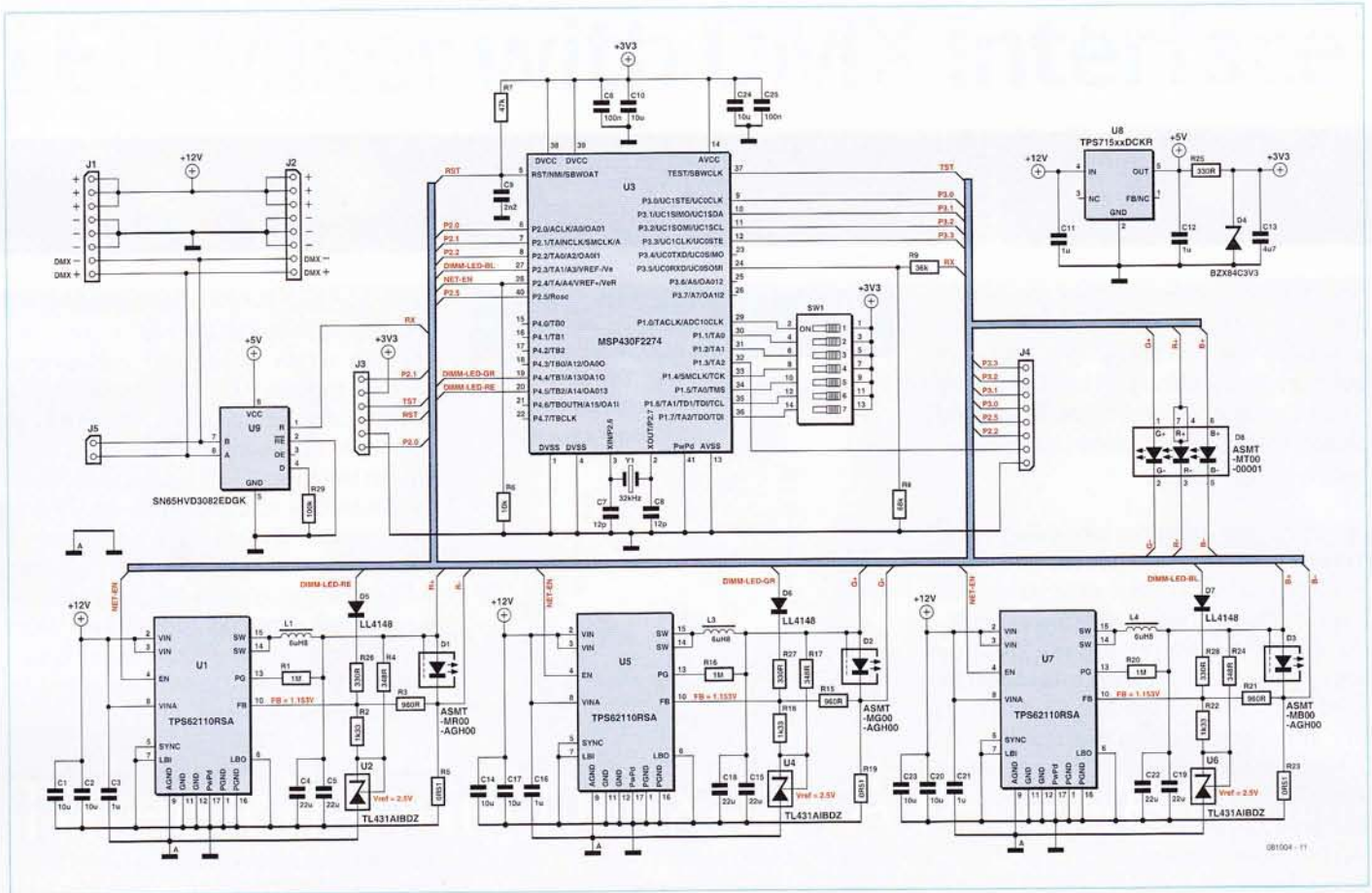

Figure 3. Complete schematic diagram of the DMX512-A three-channel receiver.

port P2.4. One USCI module (UC0) of the MSP430 is used to receive the DMX signal. The DMX bus signal conforms to the RS485 standard, but the USCI module can only process RS232 signal, so signal conversion is necessary. A type SN65HVD3082E level converter (U9) is used for this purpose. Timer modules A and B of the MSP430F2274 are used to generate the variable PWM signals that control the constant-current sources U1, U5 and U7. Using software, it is possible to generate up to three PWM signal using only two timer modules (see the 'RGB LED Mood Lighting' article in the February 2008 issue of Elektor).

Constant-current sources

The three constant-current sources are implemented using synchronous downconverter ICs with integrated power switches (type TPS62110). **Figure 4** shows the circuit diagram of one source built around U1. Thanks to the high switching frequency of 1 MHz, the external components are relatively small – coil L1 has an inductance of 6.8 μ H, while each of the two output

capacitors connected in parallel (C4 and C5) is rated at 22 μ F. The power stage can switch a peak current of 2.4 A, which allows power LEDs with rated continuous operating currents up to 1.5 A to be used. With the indicated component values, the circuit described here is configured for a current of only 350 mA. This circuit can operate over an input voltage range of 5 to 17 V. Downconverter U1 is configured as a constant-current source instead of a voltage regulator. In place of a voltage divider, a sense resistor is used to produce a voltage drop that is proportional to the current through the resistor. As the switching converter needs a feedback signal of 1.135 V at the input of the error amplifier for proper regulation, the power dissipation of sense resistor R5 would be rather high because a resistance of 3.3 Ω would be necessary with a constant current of 350 mA, or 0.8 Ω with a constant current of 1.5 A. The corresponding power dissipation would be 0.4 W or 1.7 W. A bit of circuit magic is employed here to reduce the power dissipation of resistor R5. An external reference voltage is used to apply a small bias voltage to the

error amplifier input, so that the voltage drop across resistor R5 can be reduced by the amount of the bias voltage. Resistor R5 has a resistance of 0.51 Ω the circuit shown in Figure 2, which produces a voltage drop of 179 mV at 350 mA and results in only 63 mW of power dissipation in the resistor. The value of R5 can be reduced for use with a higher current.

The drawback of this solution is that it degrades the regulation accuracy, which causes the operating point (setpoint current) to shift in response to a step change in the load. With a resistance of 0.51 Ω for R5, the accuracy is 10% at 500 mA, 5% at 1 A, and 2% at 2 A. See the inset for a description of how to determine the component values for different operating currents. As the TPS62110 has a rated maximum output voltage of 17 V, it is also possible to connect two or more LEDs in series. If you do this, bear in mind that the sum of the forward voltage drops of the LEDs and the voltage drop over R5 must be less than the input voltage of the voltage converter IC. In addition, output capacitors C4 and C5 must



have rated operating voltages corresponding to the higher output voltage. Three constant-current sources with identical component values are implemented here with U1, U5 and U7 in order to drive three power LEDs (red, green and blue).

Software

Program execution is divided into two phases. In the first phase the modules of the MSP430 are initialised, after which the program enters the second phase where it can receive and process DMX signals according to the DMX protocol.

The initialised modules include timers A and B for generating the PWM signals, parallel port 1 for reading the device address for comparison with the DMX frame, and USCI module UC0 for receiving the DMX data. In addition, calibration data stored in the data memory of the MSP430 is used to configure the clock module for a system clock rate of 8 MHz.

The timers are operated in continuous mode and clocked directly by the main clock signal. The output units of the timers are used here to generate the PWM signals. They can produce PWM signals without any involvement of the CPU until the microcontroller enters Low Power Mode 3.

The ports used here must also be initialised for proper operation of the interface to the peripheral devices. For this purpose, Peripheral Module mode is selected for the timer and USCI ports is selected. The DIP switch is connected to port 1 for address entry, so this port must be configured as an input in Parallel Port mode. A special feature here is that no external pull-up or pull-down resistors are necessary because the MSP430 has integrated resistors in the input stages of the ports. To reduce power consumption, all unused port pins are configured as outputs. This sets them to a fixed voltage level, which avoids the risk of short-circuit conditions due to floating inputs.

The DIP switch works with binary coding. The desired address in digital form must therefore be converted into binary form, which can be done with any scientific or engineering pocket calculator. Here you have to take into account a small error in

the design: pin P1.3/TA2 was accidentally routed to pin header J4 instead of DIP switch SW1, which causes gaps in the DMX address range. This error can be worked around by using the following formula:

Address for comparison with DMX frame = DIP switch value + 8 × (DIP switch value DIV 8)

where DIV is an integer division operation.

If you configure an address using the DIP switch, you can use the formula to determine which slot of the DMX frame the unit will process. To make things easier for novices, the download file for this project includes a table of switch settings. The binary values listed in the table can be set directly on the DIP switch. If you correct this error when fitting SW1 during PCB assembly

Current source component values

After determining the desired operating current for the circuit shown in Figure 2 (such as 350 mA) and choosing a value for R5, you can calculate the values of the resistor network (R2 and R3). This always involves a trade-off between regulation accuracy and power dissipation in R5. The accuracy increases as the voltage drop across R5 increases, but this also causes higher power dissipation. The following calculations are based on a design value of 1 mA for the current through the voltage divider.

$$V_{sense} = I_{LED} \times R5 = 350\text{mA} \times 510\text{m} = 179\text{mV}$$

$$V_{R3} = V_{FB} - V_{Sense} = 1.153\text{V} - 0.179\text{V} = 0.974\text{V}$$

$$R3 = \frac{V_{R3}}{1\text{mA}} = \frac{974\text{mV}}{1\text{mA}} = 974\ \Omega \quad \rightarrow \text{selected: } 887\ \Omega$$

$$V_{R2} = V_{REF} - V_{FB} = 2.5\text{V} - 1.153\text{V} = 1.347\text{V}$$

$$R2 = \frac{V_{R2}}{1\text{mA}} = \frac{1.347\text{V}}{1\text{mA}} = 1.347\text{k} \quad \rightarrow \text{selected: } 1.33\ \text{k}\Omega$$

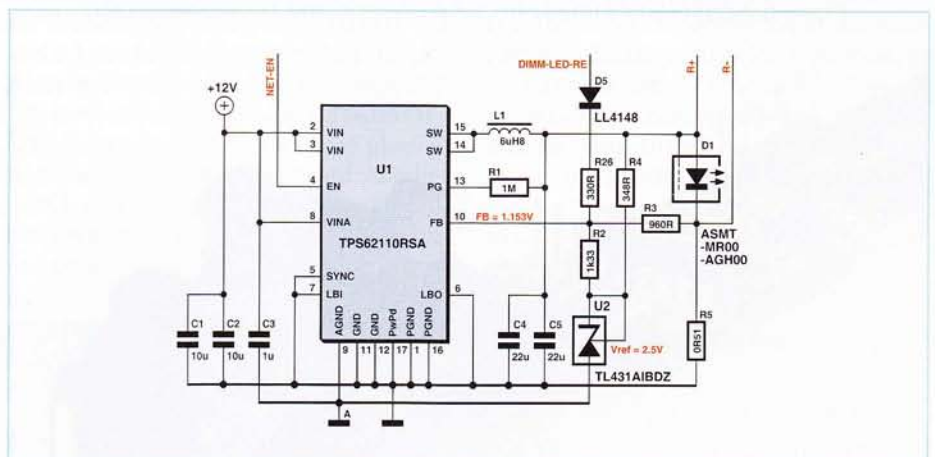

Figure 4. A constant-current source using a TPS62110.

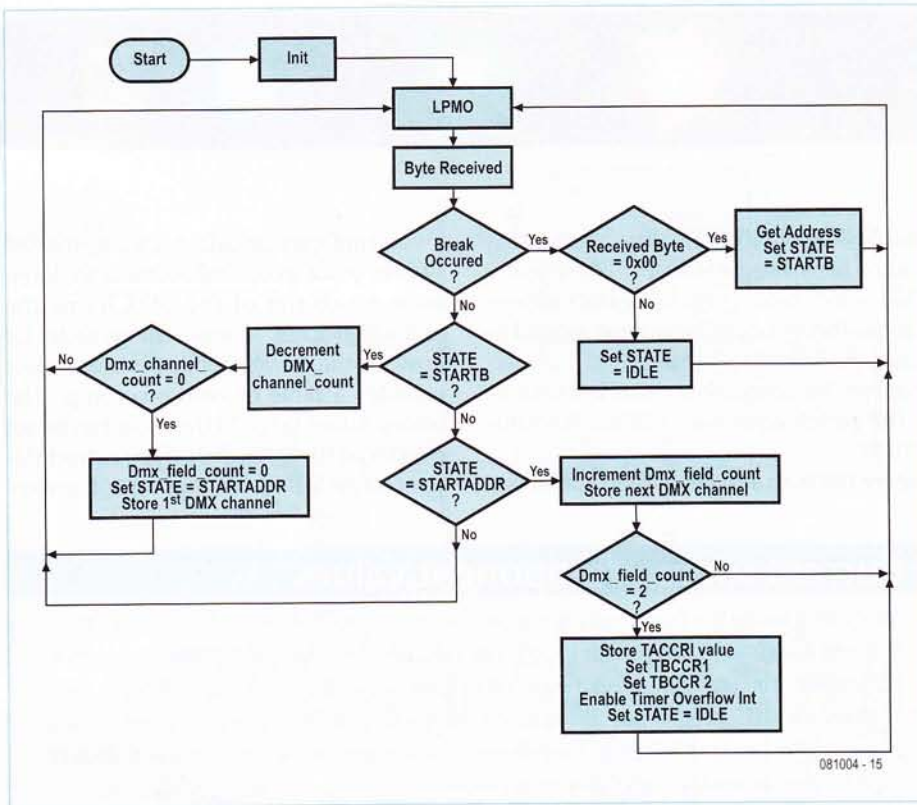

Figure 5. State machine flow chart.

bly, you can ignore this formula for dealing with the gaps in the address range. The USCI module must be configured properly to receive the DMX signal. The most important configuration parameter here is the baud rate. The DMX standard specifies a baud rate of 250 kbit/s. With a system clock rate of 8 MHz, this can easily be obtained by setting the division factor of the baud rate generator clock divider to 32 (8 MHz ÷ 250 kHz). Modulation is not necessary because the desired clock rate can be obtained using integer division. The MSP430 is synchronised to the DMX frame boundary by searching for the occurrence of a Break error in the DMX data stream. For proper processing of the signal, reception of faulty characters must be enabled in the USCI module.

After all the initiation activities are completed, the timers are started and the MSP430 is put into LPM0 mode. It awakes from this mode only when a new character is received. When this happens, the MSP430 must first synchronise to the start of the DMX frame. This is done by utilising the fact that a Break error occurs at the end of each frame when the transmitter sends a 'Space for Break', which according to the standard must have a minimum duration of 88 µs. This error is indicated by the USCI module when the next character is received, which allows the software to interpret this character as the start of the next frame. Each time a character is received, the contents of the USCI status and data registers are stored in variables so they can be processed by a state machine or used for other purposes.

The first action is to check the first value in Slot 0, which is called the Start Code. If it is zero, data reception can continue because this is the ID code for dimmer applications. The DMX frame data address set in the DIP switch is read in, and the state machine advances to the next state. Now the received slot count is decremented and compared with the read-in address. When the first dimmer channel is reached, the value for this channel and the values for the two subsequent channels are stored in an array. After all the values have been received, the



Figure 6. Adapter board fitted with XLR connectors and a power connector.

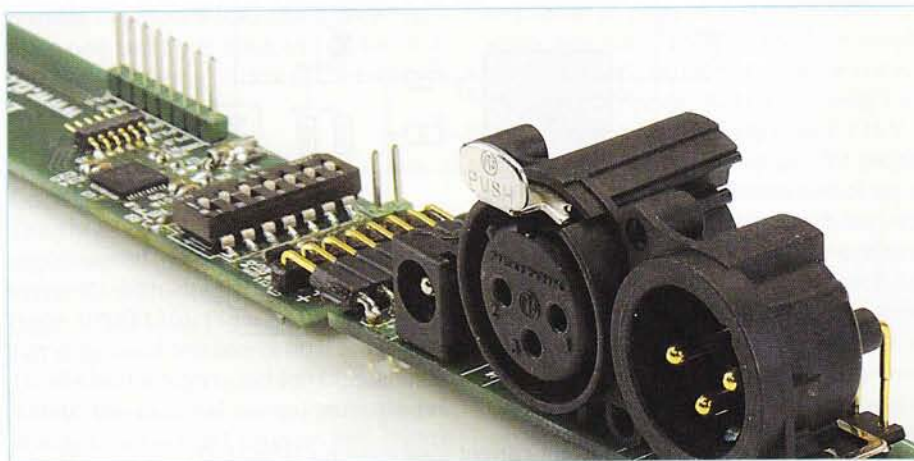

About the authors

Dirk Gehrke, who holds a Dipl. Ing. degree, was born in Münster (Westphalia, Germany) and studied communication engineering at the Technical University of Dortmund. In 1998 he joined Texas Instruments, where he has worked as a field application engineer (FAE) in England, France, the USA, and most recently in Germany (Freising). Since 2006 he has held the position of Europe, Middle East and Africa (EMEA) Business Development Manager for analogue products at TI's Freising site.

Contact: www.ti.com/europe/csc

Walter Nitzold has been studying Electrical Engineering since 2005 at HTKW Leipzig (Leipzig College of Technology, Economics and Culture), specialising in communication technology. During his course of study, he completed a practical training stage in the Field Application Engineering department of Texas Instruments in Freising, where he worked with the MSP430. This was followed by an appointment to Leipzig Research and Transfer Centre, where he concentrated on software development for the MSP430. Since April 2009 he has been working on his graduation project in the field of mobile communication. Walter also holds a scholarship from the Karl Kollé Foundation.



Figure 7. DMX receiver PCB.

timer registers can be updated. Here it is important to ensure that the registers are updated only when a timer overflow occurs, as otherwise asynchronous write operations to the registers would cause the LEDs to flicker. In the case of timer B, this synchronous updating is a built-in function of the module and is configured during device initialisation. For timer A, the interrupt service routine for the timer overflow must be used for this purpose. To this end, the most recent value for the PWM channel associated with timer A is stored temporarily in a variable and the interrupt enable flag is set for the overflow. When the interrupt occurs, the timer register can be updated synchronously to the overflow inside the interrupt service routine.

The actual values that are written to the TxCCRs registers when an overflow occurs are not the same as the values read from the DMX frame. Here the program uses three arrays with 256 entries each, which are stored in the program memory of the MSP430. The data type of the stored values is 'integer', which corresponds to a value range of 0 to 65,535. The values from the DMX frame are used to address the values in the arrays, and the values stored in these

locations are copied to the timer registers. This makes it possible to store LED-specific brightness profiles in the arrays, so that linear brightness changes can be generated despite the fact that the LEDs do not have linear characteristics.

After all the timer registers have been updated, the state machine of the DMX receiver returns to the Idle state (initial state) and waits for the start of a new DMX frame.

Figure 5 shows the full logic of the state machine.

PCB and downloads

Figure 6 shows the adapter board for the DMX and power supply connections (see Figure 2 for the schematic diagram). The narrow PCB for the three-channel DMX receiver is shown in **Figure 7** (see Figure 3 for the schematic diagram). LEDs D1, D2 and D3 can be fitted as individual components (red, green and blue), or a single RGB LED can be fitted in position D8 (with D1–D3 not fitted). The adapter board plugs in to the side of the DMX LED board. Another DMX board can be connected at the far end, and yet another board to the end of the second board.

A zip file containing an Excel file with the bill of materials (BOM), a table of address settings, the C code of the firmware, Gerber files for the PCBs, the schematic diagrams and PCB files in PCAD format, and the PCB layouts can be downloaded from the web page for this article (www.elektor.com/081004).

Future prospects

A wide variety of extensions are possible. For example, you could cascade two 8-bit DMX512-A channels and use the MSP430 to generate a PWM signal with 16-bit resolution for brightness control. You could also use a DRV88xx IC to drive a stepper motor. A connector (J4 on the DMX board) is already present for a potential extension to provide wireless interface support, which could be implemented using an RF2500T board. You could use this arrangement to communicate with board without stringing any cables, or even control battery powered receivers. It would also be conceivable to extend the address range to include all 512 channels, display the address on an LCD module, and use two buttons or an incremental encoder to set the address.

(081004)

Internet Links and References

www.OpenDMX.net (open source DMX projects)

<http://focus.ti.com/lit/ds/symlink/msp430f2274.pdf> (MSP430F2274 data sheet)

<http://focus.ti.com/lit/ds/symlink/sn65hvd3082e.pdf> (SN-65HVD3082E data sheet)

<http://focus.ti.com/lit/ds/symlink/tl431a.pdf> (TL431A data sheet)

<http://focus.ti.com/lit/ug/slvs254/slvs254.pdf> (TPS62110EVM-346 user guide)

Life Cycle Considerations

The carbon footprint behind the label

By Jens Nickel (Germany)

New refrigerators and washing machines now carry an energy efficiency label, and we are becoming ever more conscious of the importance of the standby power consumption of televisions, battery chargers and other electronic devices. But it is not just the operation of these devices that produces significant amounts of carbon dioxide (CO₂); so too does their production, transportation and their ultimate disposal. We show that these other factors can make a considerable difference to the environmental friendliness or otherwise of an appliance.

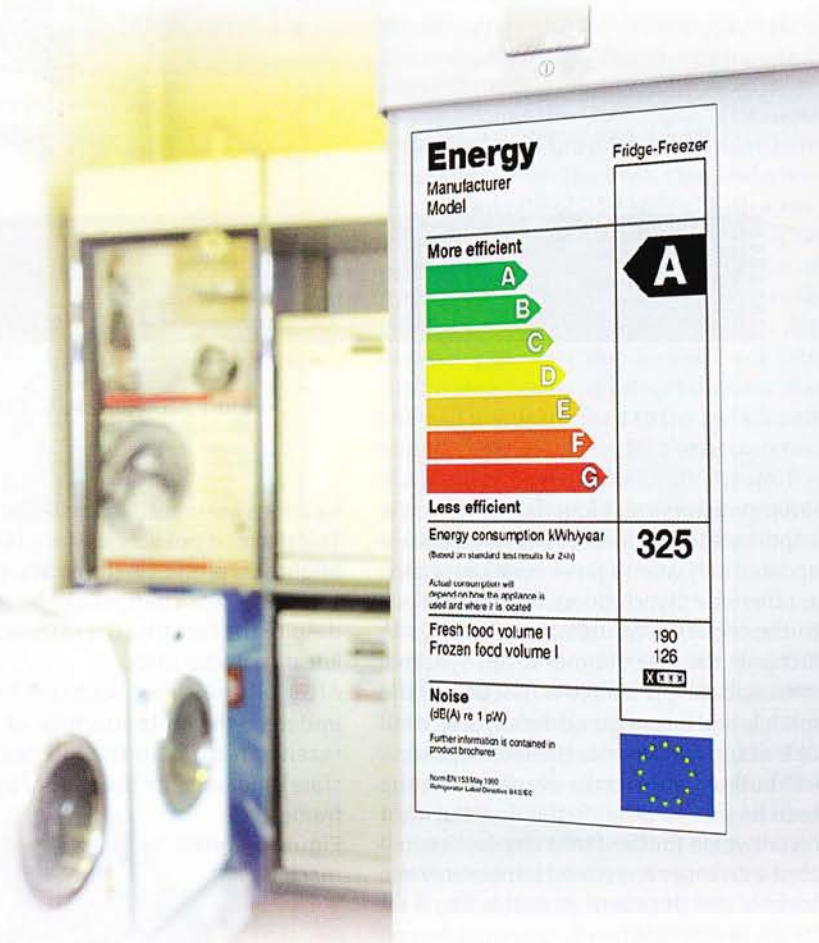

Consumers are becoming more and more aware of the power consumption of electrical and electronic devices. Whether a refrigerator, tumble dryer or washing machine carries a green 'A' or a yellow 'D' efficiency label is no longer just a detail of specification but is now an important buying criterion. The eye-catching coloured labels have brought the question of energy efficiency to the forefront of the consumer's mind.

The EU is now looking to extend its energy efficiency measures to cover stand-by power consumption [1], in particular of electronic household appliances. And with good reason: the total power consumption of all the devices in Britain in stand-by mode is comparable to the entire output of a coal-fired power station.

For example

However, we want to look in more detail at our energy budget. Fitting out a house with appliances already has a significant cost in terms of CO₂ production. A simple calculation will make this clear. Mr N from Liverpool is a parsimonious gentleman looking for a new washing machine. With an eye on his ever-increasing electricity bill he carefully seeks out an appliance that needs less

than 0.9 kWh for a standard wash cycle, giving it a category 'A' efficiency rating.

However, he does not also take into account that the machine has already travelled a considerable distance. From the container port in China it has been transported by ship to Felixstowe, and from there by lorry to Liverpool. Of course, the lorry is carrying other appliances too: to keep things simple we will estimate that the machine is one percent of the lorry's load and that the journey uses 150 litres of diesel. We will reckon the same again for the journey from the factory in China to the port, and the ship journey at twice this amount.

However, that is not the end of the story. Mr N has also made a 30 km journey by car to the shop to collect the appliance. Now we move a little into the future: after about 800 washes the washing machine develops a fault in its electronics. It is beyond economic repair. As a good citizen, Mr N puts the machine in his car and takes it to the council recycling point; from there it is taken by lorry to the recycling company, another 300 km. A total of approximately 20 litres of fuel has been used in transporting the appliance; and its total electrical energy consumption has been approximately 700 kWh.

The CO₂ budget of a kilowatt-hour

How much CO₂ is produced in the generation and transmission of a kilowatt-hour of electrical energy? We want to include not just the CO₂ emitted as a result of burning the fuel, but also that resulting from the building of the power station, the production of raw materials, and the transport of the fuel and other items. The calculation is not an easy one and depends on a number of figures and estimates: for example, where does the energy used in the manufacture of a solar panel come from? As you might imagine, various studies, for example into the overall CO₂ budget of wind and solar power stations, have come to rather different conclusions, the figures often reflecting the political requirements of the bodies commissioning the studies. A particularly bitter struggle is fought over the carbon footprint of renewable energy sources and over nuclear power. Although attractive from a carbon footprint point of view, nuclear power suffers from the problems of dealing with the waste and from considerations of safety and security.

For example, one report has claimed that the overall emissions that can be attributed to a wind turbine capable of generating 1.8 MW are around 900 tonnes of CO₂, mostly in steel and concrete manufacture. According to the study, the unit offsets this production in just five months of operation. However, opponents claim that a kilowatt-hour produced by a wind turbine cannot be offset against coal-fired or nuclear generation because the wind turbine can only produce energy unpredictably (i.e., when the wind is blowing) rather than on demand.

The table gives a few figures calculated using the 'GEMIS' software model produced by the German Institute for Applied Ecology. Figures for the first three types of power station are rather lower if they are used to generate heat as well as power.

Overall CO₂ emissions of various forms of power generation
(values given in g CO₂/kWh)

Coal-fired power station (lignite)	1.142
Coal-fired power station (anthracite)	897
Gas-fired power station	398
Nuclear power station	31
Wind farm	23
Hydroelectric power station	39
Solar cells (polycrystalline)	89

Many a mickle...

The story is still not complete. Assembling the washing machine in the factory in China takes approximately one man-day. The energy use for lighting, machinery and tools comes, suitably amortised, to around 4 kWh. Component manufacture probably accounts for another 8 kWh, and transporting the components between factories consumes another 5 litres of fuel.

A considerable amount of electricity is used in the manufacture of the steel and plastic components: we will estimate that this adds another 5 kWh to the budget. And so we go on: the steel raw material from which the components are made has been produced using fossil fuels, and iron ore has had to be extracted from the earth and transported to a blast furnace for processing. And then there is wear and tear on all the vehicles and machinery involved at all stages of the production and delivery process, and so we have to add a small fraction of the energy used in their manufacture to the energy budget for the washing machine. Then we add in the energy involved in producing and transporting fuels, building oil wells, building power stations; the list goes on.

The budget

How does the total budget over the life of the appliance look when written in terms of CO₂? First we collect together the various figures above: 700 kWh of electricity to run the machine, 50 kWh of electricity (in China) for its manufacture and a total of 50 litres of fuel for transport. This last element is easy to assess: burning one litre of diesel produces approximately 2.6 kg of CO₂. Now, how much CO₂ is produced in generating one kilowatt-hour of electricity? The

Even a wind turbine creates CO₂, mostly via the steel and concrete used in its manufacture and installation.



electricity delivered to a house is generated in several very different kinds of power station. Also, as you no doubt expect by now, we have to take into account not just the gas, coal or oil burned to generate the electricity, but also the CO₂ impact of construction and final decommissioning of the power station (see **inset**). The balance of different fuels used varies from country to country, but in Britain the generation and transmission of 1 kWh of energy releases around 0.5 kg to 0.6 kg of CO₂.

The figures for China are somewhat different, because of the large number of coal-fired power stations running at low efficiency. In the EU as well there are still power stations that emit more than 1.3 kg of CO₂ per kWh generated.

Of course, the environmental impact of generating one kilowatt-hour is not limited to the corresponding CO₂ emissions: we are reminded of the enormous (and highly controversial) hydroelectric stations in China. There are also studies that estimate the effects of nitrogen oxides and other gases on the environment and hence on human life expectancy [2a][2b]. These impacts can be converted into hard pounds and pence, allowing a direct comparison of different energy sources.

Conclusion

Back to the washing machine: although running it accounts for the lion's share of its associated CO₂ emissions (around 350 kg), the amount involved in production, transport and disposal is far from negligible (around 200 kg according to our calculations). For less power-hungry appliances this element becomes even more significant. The same goes even for appliances which are designed with energy economy in mind, although efforts in this direction nevertheless are and will remain worthwhile. If we want to do something to help the environment, perhaps the best thing is to consider whether we really need to buy a new computer, DVD player or digital camera every two years.

(070800-1)

Web Links

[1] http://re.jrc.ec.europa.eu/energyefficiency/html/standby_initiative.htm

[2a] www.needs-project.org

[2b] www.externe.info



Larger solar installations offset the CO₂ emissions resulting from their manufacture, transport and installation in a small number of years.

(Photo: German Federal Environment Ministry/Brigitte Hiss).

Escaped from the Elektor Lab ...



Looks like I found a bug...

No it's a feature! This predictable reply was met with a chorus of groans. No it's definitely a bug, look... he handed me the solar powered battery charger. He was right; this feature had six legs and spots on its back. The ladybird must have flown in through a window and decided to hibernate in our eco-friendly solar charger that's now almost ready for publication. How apt, I thought, of

all the equipment and gear laying around in the lab this tiny creature had picked this piece of equipment. The solar charger generates power but in operation produces no pollution or greenhouse gases; it was almost as if Nature had given the solar charger its seal of approval.

if the data sheet is wrong? It doesn't happen often but take the BC639 transistor. This device comes packaged in a plastic TO-92 outline and all the data sheets agree; with the transistor's flat face on the bench and its leads pointing towards you they read, from left to right; base, collector and emitter. I say they all agree but I overlooked a data sheet by Siemens, it tells us the leads are emitter, collector and base! Well at least

It says what?

... How many times have I got to tell you, R-T-D-S! (look at the data sheet) We often hear these words of advice given to a young engineer struggling to get their circuit to behave. We have faith in data sheets they are the font of all knowledge. What

they agree on the centre lead. In the years BI (before Internet) engineers would have a stack of data books to which they could refer, any printing errors could be corrected

with a pencilled note. Nowadays Google finds the information for us. On a bad day you would by chance click on the Siemens data sheet and end up wiring the transistors incorrectly. The result is an afternoon of frustration hunting for the source of the problem. This is exactly what happened to one of our engineers working on a new design. He wasn't happy, maybe the advice should be: have you checked the data sheet for errors!

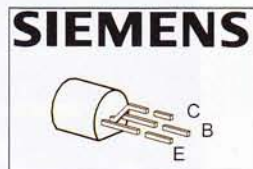
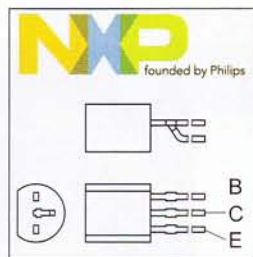

So what's new?

We are familiar with microcontroller evaluation boards that come in a small memory-stick format to plug into a PC's USB socket. Similar designs are available from many semiconductor and software tool manufacturers and make a convenient development platform. So when this system from TI dropped on our desk (<http://focus.ti.com/docs/toolsw/folders/print/ez430-chronos.html>) we weren't expecting any surprises. Just like similar systems from other manufacturers, the development board is made up of two small plug-together cards. The first contains the chip programmer and plugs into a PC USB port. The second tiny board contains the microcontroller.

This kit however has one more trick up its sleeve (literally); it includes an example target system with an LCD display i.e. a sports watch! The chip programmer board is similar to other TI kits. Once the microcontroller card is programmed it can be fitted into the watch and the cover screwed down. The controller type CC430F6137 is an MSP430 with an RF core allowing wireless communication with say a heart rate sensor or pedometer. We haven't yet had a chance to put this system to the test but look out for more details in the future.



ELabsInside@Elektor

- Got a question for the designer of an Elektor circuit?
- Any contributions or comments on the E-Labs Inside stories?
- Suggestions of boards or electronics software that you think would be interesting to review
- Discovered anything new that you want to tell us about?

Don't hesitate; we look forward to your feedback sent to elabsinside@elektor.com, please include [e-labs] in the subject line.

A look at the Altium NanoBoard 3000

By Jens Nickel

A few months ago Australian software and tools specialist Altium cut the price of its Altium Designer electronic CAD software suite considerably; they also added a new, relatively low-cost, member to their NanoBoard family of FPGA-based development boards. The NanoBoard 3000 sells for around three hundred pounds [1] and includes a special twelve-month licence for the Altium Designer software along with various items of licence-free intellectual property (IP), such as an 8051-com-

patible soft processor core. The manufacturer has been kind enough to let us have one of these kits.

would need in building modern applications, especially in the mobile arena. At the heart of the board is a (soldered-in) Xilinx Spartan 3AN FPGA. The board contains everything needed to develop and test a complete embedded system, including processor, memory and peripherals: in fact, these components are implemented as 'soft IP cores' in the FPGA, and can be used without the developer needing to be familiar with Verilog or VHDL. Programming is done by connecting together ready-made functional blocks using a graphical interface.



The manufacturer's hope is that once a prototype has been developed using the NanoBoard 3000, the designer will obtain the 'Custom Board Implementation' version of the software, which has features for printed circuit board design and for interfacing to a mechanical engineering CAD program. This integrated approach can drastically reduce the time taken to reach mass production; the disadvantage is that it takes considerable effort to learn to use the powerful features of the electronic CAD suite.

We found that a good way to get started was to follow the step-by-step tutorials on the NanoBoard 3000 website (click on 'Training Room' towards the bottom of the home page [2]). The short, well-produced videos show how to develop an example application, which makes it easy to understand how the software works and how powerful it is. The Altium website [3], especially under the 'Community' and 'Training' menu

items, contains a great deal of additional information on Altium Designer, including further training videos and manuals, a wiki and user discussion forums.

Installing the program is straightforward, and as soon as you have created an account on Altium's website, you can obtain the twelve-month licence mentioned above for use in conjunction with the board. A software package can also be downloaded (free, but registration required) from the website of Xilinx, the FPGA manufacturer. These tools, which are responsible behind the scenes for placement and routing in the FPGA, integrate seamlessly with Altium Designer.

The user interface is, of course, professionally presented and

patible soft processor core. The manufacturer has been kind enough to let us have one of these kits.

First impressions on opening the box were very positive. The board, mounted in an elegant black frame, includes everything the electronics engineer could possibly want: a TFT LCD panel (with touch-screen), an audio codec, large amounts of SDRAM, SRAM and Flash memory, two SD card slots, eight full RGB LEDs, four PWM outputs, a four-channel ADC, a four-channel DAC, four relays, a real-time clock, and much more besides. The interfaces available include USB and RS232, as well as Ethernet and a range of audio and video interfaces (S/PDIF, MIDI, VGA and so on). The wide range of peripherals covers most of the possibilities that an engineer

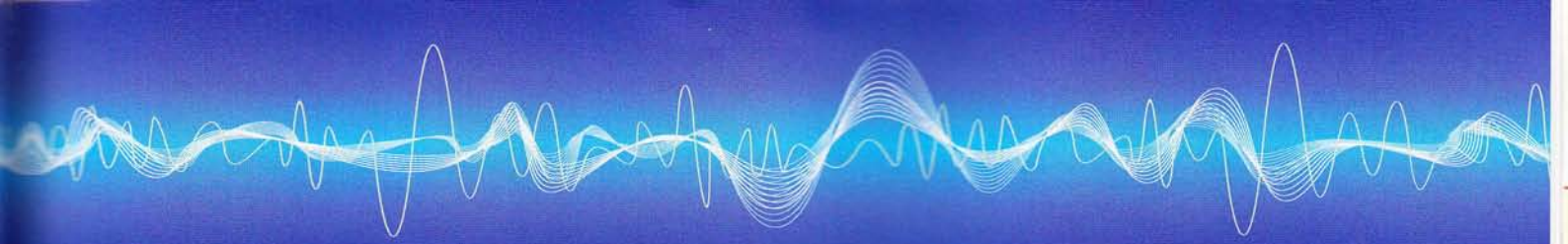

easy to use. There are many project examples, arranged into groups under headings such as 'Analogue', 'Audio', 'Display' and 'Networking', and these can be loaded into the main project window with a click of the mouse. From here various views of the project are available. For example, the circuit diagram view shows the connections between various peripherals (such as the display) and the modules in the FPGA. A further click compiles the project, and uploading the design (over USB) is also easy. In order to get a better impression of the program we worked through the first example from the training videos. The aim of this example is to drive the RGB LEDs on the board and control their colour and brightness. This involves appropriately configuring and connecting the LEDs themselves, an LED controller, and a control interface with sliders and a seven-segment display. The wiring is all carried out in the virtual on-screen world; there is no need to set jumpers on the board, plug in new components or do any soldering.

The LED controller is one of the many soft IP components for the FPGA that come with the board. The control interface, however, is hosted on the PC, which must therefore remain connected to the board while the design is running. As everything is manually driven from the PC, this first example application does not need to use the microcontroller core in the FPGA.

The steps in building the design are well documented in the video and in a downloadable PDF, and we managed to get to the desired result quickly (see accompanying screen shots). However, it took some practice to get to the point where we were comfortable developing our own projects, which is hardly surprising in view of the complexity of the program.

In conclusion, the kit is primarily aimed at those with little experience of 'soft designs', perhaps small development groups or teams of university students who have already worked on several microcontroller projects and who wish to broaden their experience by learning how to use FPGAs. For a reasonable price you can buy a fully-kitted-out system to experiment with this modern approach to development. The FPGA is then just a means to an end, namely that of developing a prototype as quickly as possible. If, on the other hand, you are interested in FPGAs for their own sake, and simply want to experiment with using VHDL, you will be able to find smaller and cheaper boards on the market. Assuming you have a suitable programmer, files created using Altium Designer can be used to program any FPGA of the same type, even if it is on a different make of development board or even on a purpose-designed board.

(090555)

[1] <http://uk.farnell.com/altium/>

[2] <http://nb3000.altium.com/intro.html>

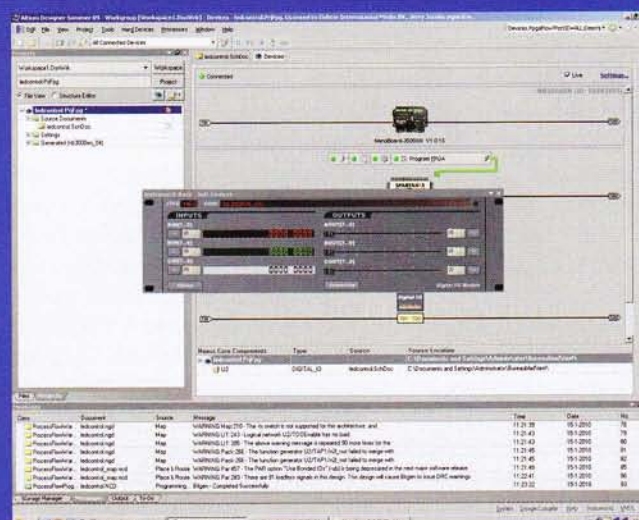
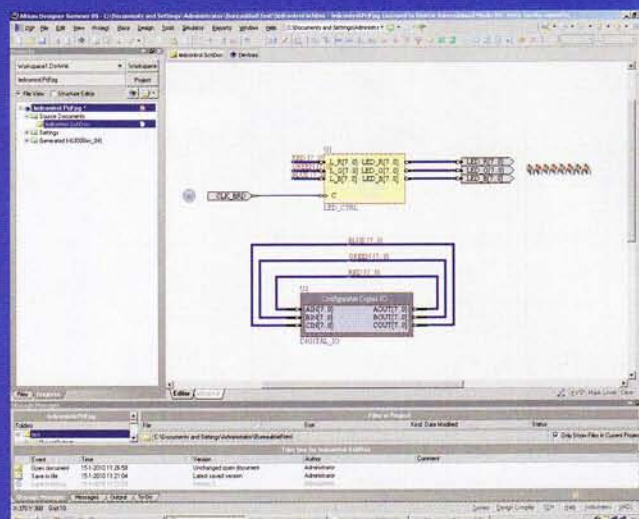
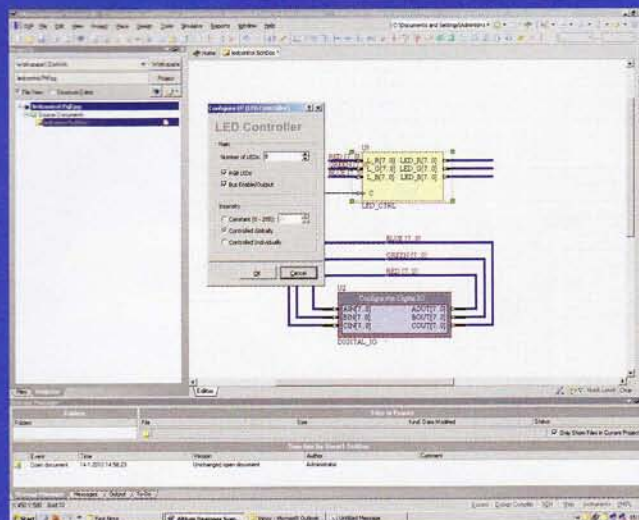

Tackle the crackle - but do it properly!

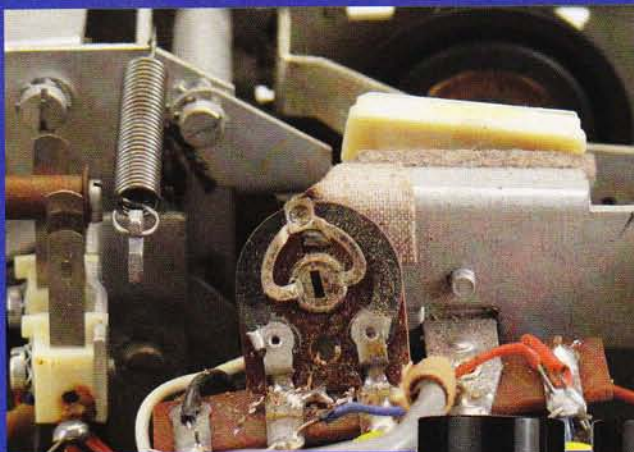

By Jens Nickel

We suspect there are some of our readers who choose not to equip their listening space with the latest surround-sound, Ethernet-connected, WiFi-enabled, 5.1 THX-certified media player. Instead they would most probably be using a quality turntable or transcription deck. For sure the heat rising from the valve amplifier would be keeping the room nice and cosy. Old equipment has a certain charm that some people find preferable to the more modern equivalents.

Often with equipment of this age, pots and wafer switches become distinctly noisy. It can spoil the atmosphere if every time you adjust the volume the speakers make a sound like a sack of spanners being dragged across the floor.

The switch contact surfaces and pot wipers tend to build up an oxide layer with time which leads to increasing contact resistance and sometimes intermittent contact. Contact cleaner squirted through an opening in the pot or switch housing usually makes a huge improvement but the effect can be short-lived. Eventually the crackle returns and sometimes it seems even louder than before. There are several proprietary switch contact cleaning sprays available and Kontakt 60 (K60) is one of the best known. It is manufactured by Kontakt Chemie, a subsidiary of CRC USA.

CRC's web site [1] contains detailed usage instructions of their product range. It appears little known that to clean switches and pots effectively Kontakt 60 should be used strictly in combination with Kontakt WL and Kontakt 61. The reason is that K60 dis-

solves the oxide layer but leaves a residue which unless removed will eventually dry out and make a poor contact again.

The vapour produced is flammable so ensure there is no source of ignition nearby and also unplug the equipment from the AC power line before you start. There are three steps altogether in the correct cleaning sequence. Ventilate properly!

1. Spray the contacts sparingly with Kontakt K60, rotate the pots and wafer switches back and forth to distribute the fluid. If the contacts are accessible clean them thoroughly using a fine brush. Carefully remove any debris. Leave the contacts to dry.

2. Spray liberally with Kontakt WL, this will dissolve and remove the residue left by the K60, now leave to dry.

3. Finally spray with Kontakt 61 (K61) sparingly; this coats the contacts with a thin protective film to inhibit further oxidation.



Sometimes the pot has been so well used that the resistive track is worn out in places or pits have developed on the surface. In extreme cases oxide build-up can cause the pot to fail. The only real solution then is to replace it. When all else fails take a look at Internet reference [2] where you'll find some really novel suggestions to help bring the pot back to life and helpful tips also.



(100022)

[1] www.crcind.com/csp/web/ProdDisp.csp?country=ALL&product=KONTAKT 60&brand=KOC&lng=3

[2] <http://www.vintage-radio.net/forum/showthread.php?t=36778>



**We add value to PCBs
when others just sell it.**



Designing Service

3D Enclosure Designing Virtual Assembly PCB Design

- One Stop Manufacturing Service
- \$10 ea. for 5pcs 4"x4" 2L
- Free Solder Mask & Silkscreen



- Free Components



- Free Assembly

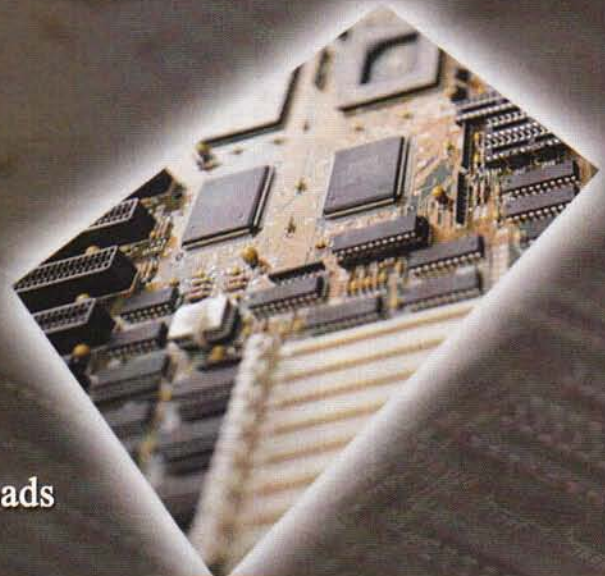

Assembly Components Pcb
Enclosures Fpcs Keypads

www.EzPCB.com

Email: sales@ezpcb.com

Please Visit www.machinepieper.com For Machining

THE ORIGINAL SINCE 1994

PCB-POOL[®]

Beta LAYOUT

Email: sales@pcb-pool.com
Free Phone UK: 0800 389 8560

**Servicing Your complete
PCB prototype needs.**

NEW!

8 hour
prototype service

NEW!

1 mm material
now available

FREE!

Free Laser SMT Stencil
with all PCB prototype
orders

www.pcb-pool.com

REFLOW-KIT[®]

Beta LAYOUT



Now available:
Tools and accessories
for prototype PCB assembly

www.reflow-kit.com

Supported File Formats



Beta
LAYOUT

An ATM18 Passepartout

Generate passwords and send them to the PC via the USB port

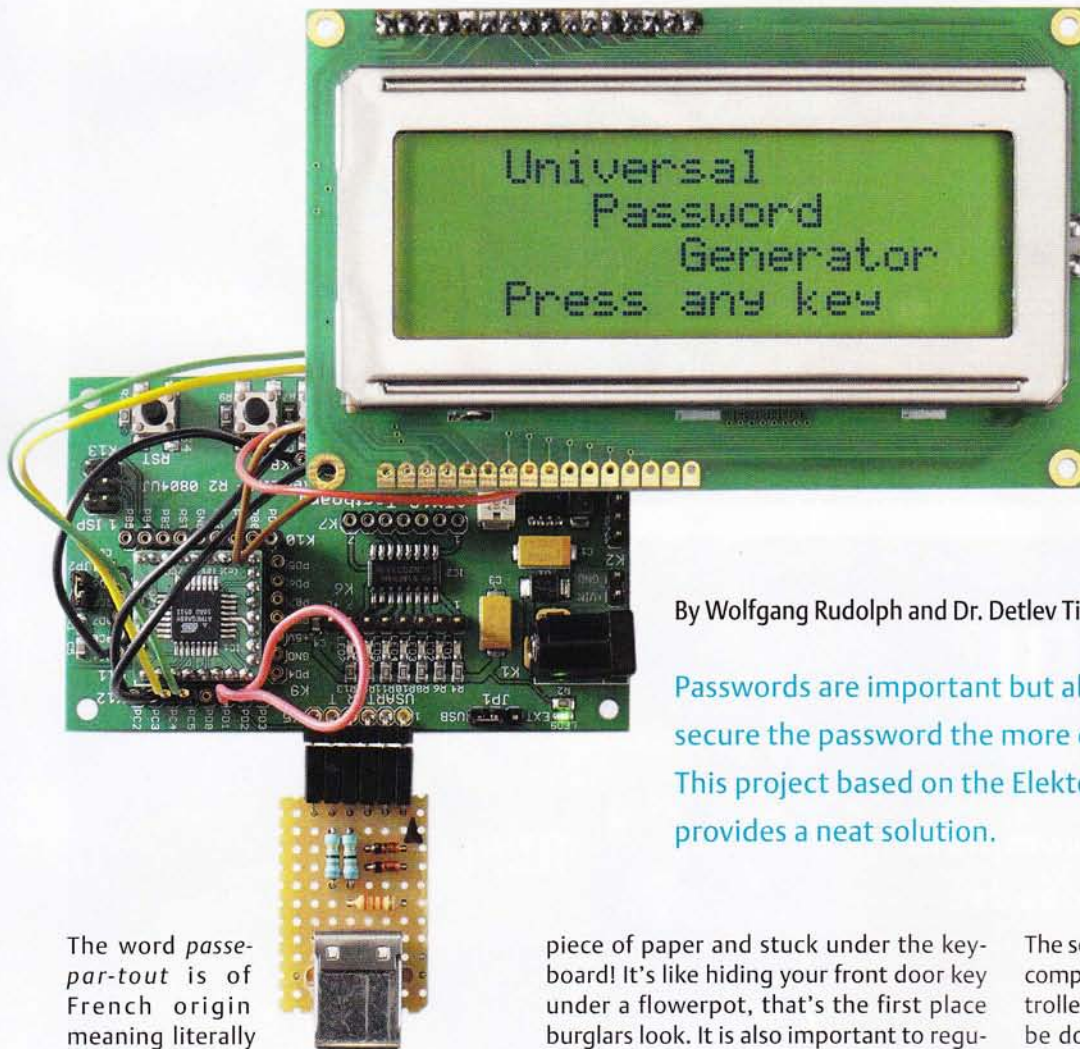

By Wolfgang Rudolph and Dr. Detlev Tietjen (Germany)

Passwords are important but also annoying. The more secure the password the more difficult it is to remember. This project based on the Elektor ATM18 ATmega board provides a neat solution.

The word *passep*-*par-tout* is of French origin meaning literally 'pass everywhere'.

A single key that can open several locks is also known as a passkey or master key. In the real world such a key would be used by a house manager of say student accommodation. Here each student's personal key only opens their own door but the house manager's passkey can open all of them. If the key is stolen however every door is insecure.

For this reason it is important that we don't use the same password on our computer and every secure website that we visit on the Internet. Each password must be unrelated and as random as possible and under no circumstances should be written on a

piece of paper and stuck under the keyboard! It's like hiding your front door key under a flowerpot, that's the first place burglars look. It is also important to regularly change your passwords. This means that before long we could typically have around fifty such passwords to remember and if, as recommended we change them every month this amounts to 600 strings of meaningless random characters to memorise every year. Hands up all those who follow this advice... no I thought not. Unless you possess Rain Man's ability of total recall you probably take a chance by using easy to remember short passwords and never bother to change them. There are some commercial solutions available on the market to help manage passwords, some good, some not so good and they are often difficult to use.

The solution suggested here requires a few components together with the ATM18-controller test board plus software which can be downloaded for free from the Elektor website [1]. The controller generates secure passwords and sends them to the PC's USB port; we only need to remember a short four digit PIN. All the complex calculations are performed by the microcontroller.

The Hardware

To transfer the passwords from the ATM18 test board to the PC it is necessary for the ATM18 to emulate the function of a USB connected keyboard. Communications normally passing between such a keyboard and the PC will therefore be generated in the ATM-18 software. The only additional hardware needed for this project is a small extender board which fits between the USB

port and the controller board. The extender board is fitted with two 3.6 V zener diodes and two 68 Ω resistors. An additional resistor connected between pins 1 and 2 on the USB connector signals to the PC that a slow USB peripheral is connected. The circuit with the Zener diodes and resistors (see **Figure 1**) can also be found on the Internet [2]. A current of 20 mA flowing through the 3.6 V Zeners produces a voltage of 3.3 V. This is exactly what the level needed to enable the interface to work with USB signals.

The circuit is so small it could in fact be built directly on the ATM18 board's RS232 connector (K5). It could also be hand wired to a connector or built on a small square of perfboard as we have done here. Be aware that pin 6 (GND) of the extender board connects to K5 pin 1 on the ATM18 test board, pin 5 connects to K5 pin 2 etc. Looking at the board from above with the printing the right way up, pin 1 of all the connectors is always to the left.

On pin header K12 of the ATM18 test board it is necessary to bridge PD1 and PD2 (INT0) so that INT0 is available at connector K5.

The two-wire LCD connects to PC4 (Data) and PC5 (Clk), the push buttons to PC1 to PC3. In `lcd.h` and `btn_config.h` it is possible to re-assign these pins if necessary.

The Software

The USB routine is a little tricky. We have used the familiar `v-usb driver` [3] and a part of the `HIDKeys project` [4]. As long as our 'keyboard' complies with the HID (Human Interface Device) specification it will not be necessary to install any driver. Both projects are under GPL.

The USB driver essentially consists of two parts; an Interrupt Service Routine (ISR) and the function `usbPoll()`, which in the main loop must be called as often as possible, at least every 50 ms. Should it fail to achieve this we get a TimeOut by the host (PC) error and the link stops working. Likewise the ISR response time is critical, any other ISR must be kept as short as possible or stopped to avoid slowing down the controller's response time.

To meet the 50 ms time constraint the program does not use any wait loops i.e. where the program is held in a loop waiting for a key press. Instead execution is controlled

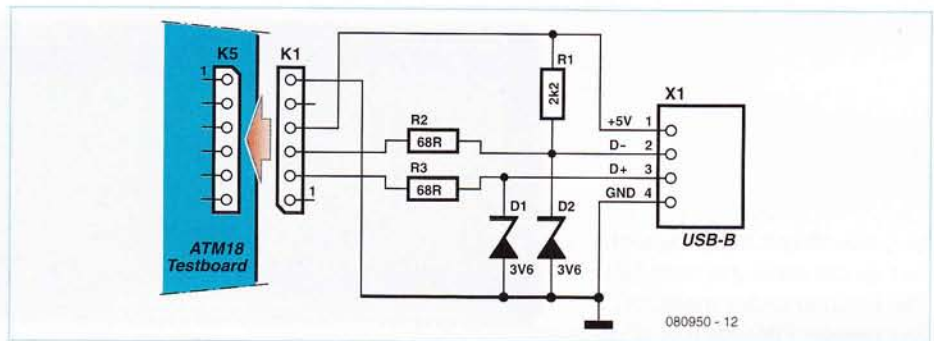

Figure 1. The socket on the left connects to K5 on the test board. The socket on the right plugs into a PC USB port.

by the value of the 'status' variable which is continuously updated. A sequence of `switch()` statements takes the program to the necessary routine. Otherwise the program remains in its main loop.

The list of Internet addresses which require a codeword to be generated must be typed into the source code before the program is compiled. Four entries have already been included in 'main.c' starting at line 22 (see **Listing 1**). The number of entries can of course be added to or deleted and the block expanded as necessary.

Each entry in this block has the same format: two numbers indicate the password length (it can be up to twenty characters long) now following the colon the web address of the site is entered by hand (20 characters maximum). The 20 character limit is to ensure that both the address and password will fit onto one line each of the display. The program uses around 4 KB of memory and each address entry uses 24 bytes. The Flash memory has around 3 KB free to store the addresses.

The ATmega test board does not store the password in memory, instead it calculates it using the displayed web address and sends it to the PC when the button is pressed to transfer it. At the PC it receives the string of characters and deals with them as if they had been typed in on the keyboard. When the password generator is connected to a different PC with say a foreign keyboard layout there will be some compatibility issues. Some languages have special characters and position the common characters in different places on the keyboard.

Each time a key is pressed a keycode is sent to the PC. The processor looks up the ASCII code for the key press in a look-up table. This works fine until you use a foreign lan-

guage keyboard which has keys to produce special characters. A US or UK keyboard for example will generate the number 28 for the Y key and 29 for the Z key (QWERTY). A German keyboard switches these two codes around because the key positions are swapped (QWERTZ).

This special case is intercepted in the 'main.c' routine according to the language selected (see **Listing 2**, `#ifdef [language]`). The other special characters are not so easy to deal with. For the sake of compatibility it simplifies matters if we limit the range of characters used to generate the password to the basic character set. This is achieved in software by editing the 'main.c' at line 329 by removing from the string any unwanted characters. The standard character set in `letters[]` is limited to include numbers 0 to 9 and characters a to z and A to Z.

```
const char letters[] = "0123456789ABCDEFGHIJ-
KLMNOPQRSTUVWXYZabcdefghijklmnopqrstuvwxyz";
```

A maximum password length of 20 characters gives very good security but even if a few characters are taken out it will not compromise security unduly.

Once all the changes, new addresses and password lengths have been added to the program it can be compiled and then programmed into the controller's Flash memory.

The `avr-gcc` compiler was used.

In operation

When the board is plugged into the PC's USB port the LC display shows the start screen (**Figure 2**).

After pressing a pushbutton your four-digit PIN number can now be entered. More num-

bers are difficult to handle without special measures in 16 bits. The banking sector maintains a four number PIN code that offers sufficient security and they have been using them for decades, so it should also be good enough for us. The program uses the 1's complement of the entered PIN so that the special case where the PIN is chosen as 0000 does not cause a problem.

The password is produced by combining the four number PIN, the address of the visited website selected from a list stored in the test board and the output sequence of a pseudorandom generator. The pseudorandom sequence is important; it needs to generate a reproducible sequence each time it is called so that the same unique password is generated when combined with the PIN and web address. A pseudorandom sequence generator must be written in software, the library function random() can't be used, it generates a different value each time it is called when the program is changed and recompiled.

The PIN is entered into the ATM18-controller board using three pushbuttons; **Figure 3** shows the LC display.

The first button increments the displayed value. The second pushbutton enters the value to the controller and moves on to the next number in the PIN. The third pushbutton gets you back to the start of entering the PIN.

With the PIN entered, the second button can be pressed to display the address of



Figure 2. Start.



Figure 3. Enter your PIN.



Figure 4. Select web address.

the first stored web site with its password shown on the line beneath (see **Figure 4**). Pushbutton 1 can now be used to step through the stored websites. A press on pushbutton 2 will send the password for the displayed website to the PC. Pushbutton 3 returns you to PIN entry mode.

With just a few simple button presses the password generator now sends a really

long, complex (and therefore secure) password to the website very quickly.

The menu language can be changed in the file 'locale.inc'. At present the options are German or English. The language is defined on line 16 of 'main.c'. The tests were conducted with a 16 MHz clock. Other clock frequencies are also possible (providing the USB driver can keep up^[2]), the frequency is defined by the value in F_CPU. The usbdviasm.S file needs to be modified for this option to function. Note that when a new version of the driver is used the modification will be overwritten.

A force for good or bad?

Encryption can be used criminally to hide illegal content. Some encryption is extremely robust so that investigations concerning counter terrorism, child indecency and domestic extremism often uncover encrypted files which may have incriminating content but cannot be read. Laws introduced in some countries recently give officers the power to request disclosure of the key associated with an encrypted file. Failure to disclose may result in conviction^[5].

With the password generator described here plugged into your PC the process of sending a password to a web site is made easier and more secure. It gives another layer of security to help protect your personal information from unscrupulous hackers.

(080950)

Weblinks

[1] www.elektor.com/080950

[2] <http://vusb.wikidot.com/hardware>

[3] <http://vusb.wikidot.com>

[4] www.obdev.at/products/vusb/hidkeys.html

[5] www.surveillancemissioners.gov.uk/docs1/osc_annual_rpt_2008_09.pdf

Listing 1.

```
#include <avr/io.h>
#include <util/delay.h>
#include <avr/pgmspace.h>
#include <avr/interrupt.h>
#include <avr/wdt.h>
#include <stdlib.h>
#include <string.h>

#include "usbdrv.h"
#include "oddebug.h"
#include "btn_config.h"
#include "btn.h"
#include "lcd_2wire.h"
```

```
#define ENGLISH
#include "locale.inc"

typedef char entry_t[24];

entry_t addresses[] PROGMEM = {"20:www.
elektor.com", "12:www.anywhere.com", "08:www.
mybank.com", "11:www.anyweb.com"};

const uint8_t n_o_address = sizeof(addresses) /
sizeof(entry_t);

const char empty_string[21]
PGMEM = "          ";
```

Listing 2.

```
/* Keyboard usage values, see usb.org's
 * HID-usage-tables document, chapter 10
 * Keyboard/Keypad Page for more codes.
 */
```

```
#define MOD_NOMOD          0
#define MOD_CONTROL_LEFT  (1<<0)
#define MOD_SHIFT_LEFT    (1<<1)
#define MOD_ALT_LEFT      (1<<2)
#define MOD_GUI_LEFT      (1<<3)
#define MOD_CONTROL_RIGHT (1<<4)
#define MOD_SHIFT_RIGHT   (1<<5)
#define MOD_ALT_RIGHT     (1<<6)
#define MOD_GUI_RIGHT     (1<<7)
```

```
#define KEY_TAB      43
#define KEY_CR       40
#define KEY_SPACE    44
#define KEY_DOT      55
#define KEY_KOMMA    54
#define KEY_MINUS    86
```

```
#define KEY_A      4
#define KEY_B      5
#define KEY_C      6
#define KEY_D      7
#define KEY_E      8
#define KEY_F      9
#define KEY_G     10
#define KEY_H     11
#define KEY_I     12
#define KEY_J     13
#define KEY_K     14
#define KEY_L     15
#define KEY_M     16
#define KEY_N     17
#define KEY_O     18
#define KEY_P     19
#define KEY_Q     20
```

```
#define KEY_R      21
#define KEY_S      22
#define KEY_T      23
#define KEY_U      24
#define KEY_V      25
#define KEY_W      26
#define KEY_X      27
```

```
#ifdef DEUTSCH
#define KEY_Y      29
#define KEY_Z      28
#else
#define KEY_Y      28
#define KEY_Z      29
#endif
```

```
#define KEY_1      30
#define KEY_2      31
#define KEY_3      32
#define KEY_4      33
#define KEY_5      34
#define KEY_6      35
#define KEY_7      36
#define KEY_8      37
#define KEY_9      38
#define KEY_0      39
```

```
#define KEY_F1     58
#define KEY_F2     59
#define KEY_F3     60
#define KEY_F4     61
#define KEY_F5     62
#define KEY_F6     63
#define KEY_F7     64
#define KEY_F8     65
#define KEY_F9     66
#define KEY_F10    67
#define KEY_F11    68
#define KEY_F12    69
```

```
#define NUM_KEYS   128
```

Small & Open Source

Open source embedded operating systems

By Harald Kipp (Germany)

The article 'Femto OS' in last month's *Elektor* provided a practical entry point into the world of AVR multitasking operating systems. If it inspired you to investigate further and take a look on the Internet, you doubtless discovered plenty of other Open Source projects of this kind.

It's ironic that the remarkable capacity of the Internet to catalogue the total world's knowledge doesn't make searches of this kind simple. On his first stocktake the author was faced with no fewer than 30 Open Source projects concerning 8-bit microprocessors. That said, many of these replicated the Sleeping Beauty's slumbers and around only half of the projects had been updated in the last six months. Our survey is deliberately confined to **active** projects even if our selection is somewhat subjective, without any judgement on the projects' merit or quality. Of course there may well be genuine treasures buried in the currently inactive projects too, just waiting to be rediscovered. The open source code will make it easy to find out! Right, let's take a deep breath and cut straight to the crucial question: what actually is an operating system? Even experts have difficulty in giving an unequivocal answer. But in general an operating system fulfils two functions, to manage resources and conceal hardware technicalities from users. Among the resources we can count the CPU, memory and input/output devices. Details of the hardware are concealed within application programs so that these can run differing hardware without customisation.

CPU management

All of the operating systems presented here facilitate the operation of several tasks at once, quasi-simultaneously. The technical term for this is 'multitasking' and its advantages were covered comprehensively in

last month's issue [1], using Femto OS as an example. The change from one task to another is called *context changing* and this process can be more or less burdensome according to the type of operating system.

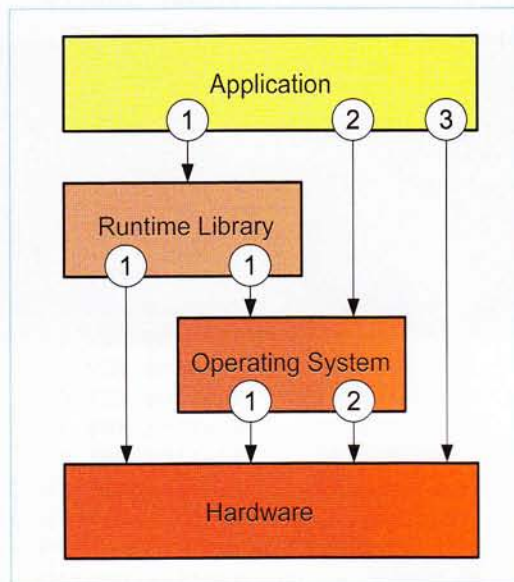

Figure 1. The need to access a runtime library makes applications hardware- and operating system-dependent (1). Accessing via an operating system (2), as opposed to making direct calls (3), is another way of reducing dependence on particular hardware.

Basically there are two types of multitasking to support operating systems, namely cooperatives und pre-emptives. In cooperative multitasking a context change takes place only when a task hands

control to the CPU voluntarily. As a result the application is protected from being interrupted at any arbitrary stage. In practice this works adequately well, since many applications spend the largest part of their time waiting for external events. The operating system Nut/OS (see Table) of the *Elektor* Internet Radio [2] demonstrates this very clearly.

The context change is carried out with the help of short assembler routines built into the operating system, which does of course make porting across to another type of CPU more difficult. The Protothreads project of the Swedish Institute for Informatics has demonstrated that multitasking is nevertheless possible even in pure C code. There's a disadvantage that non-static local variables lose their content in context changes. This technique is used extensively in the Contiki operating system (see Table).

Pre-emptive multitasking places higher demands both on the operating system and on the application. In this situation the task running currently can be interrupted at any time, as soon as an event initiates another task with higher priority. For the programmer each task has to be treated as an interrupt routine. If you have already done some programming with interrupts you will know the potential pitfalls. Calls to global variables can lead to errors if precautions are not taken. Routines must additionally be made re-entrant capable [3], if they are to be used 'simultaneously' by several tasks. The key advantage

Survey

This listing includes only operating systems that support at least one 8-bit microprocessor and are under ongoing development. Under *Target Platforms* we have listed simply the generic families, in which some members may no longer have active support. The *Licence* named is the main licence, which may differ from the original in some details.

Project	Target Platforms	Licence	Notes	Link
BeRTOS	AVR, ARM	GPL	Numerous drivers, graphics	www.bertos.org
ChibiOS/RT	AVR, ARM, MSP430, Coldfire, H8S, x86	GPL	Secure, static design	http://chibios.sourceforge.net
Contiki	6502, ARM7, AVR, MSP430, Z80, etc.	BSD	TCP/IP, 6LoWPAN, graphics	www.sics.se/contiki
Femto OS	AVR	GPL	Very small and compact	www.femtoos.org
FreeRTOS	ARM, AVR, MSP430, Coldfire, x86, PPC, etc.	GPL	Wide distribution	www.freertos.org
FunkOS	AVR, ARM, MSP430	Sleepycat	Graphics	http://funkos.sourceforge.net
HACK-RTOS	Zilog CPUs	GPL	Compact, Assembler only	www.hack-rtos.ru
Helium	HCS08, Coldfire	GPL	Small kernel	http://helium.sourceforge.net
Nano-RK	AVR	GPL	Sensor network	www.nanork.org
Nut/OS	ARM, AVR	BSD	TCP/IP, POSIX-like	www.ethernut.de
NuttX	8052, ARM, Z80, etc.	BSD	TCP/IP, POSIX API	http://nuttx.sourceforge.net
scmRTOS	AVR, ARM, Blackfin, MSP430, etc.	LGPL	C++	http://scmrtos.sourceforge.net/ScmRTOS
TinyOS	ARM, AVR	BSD	Sensor network, nesC	www.tinyos.net
TNKernel	ARM, PIC24, HCS08, Coldfire	BSD	ITRON API	www.tnkernel.com
YAVRTOS	AVR	LGPL	Simple task scheduler	www.chris.obyrne.com/yavrtos

of pre-emptive multitasking is nevertheless obvious: high-priority tasks can be handled with the minimum of delay.

In actual applications, which method would work better really depends on the individual situation. Some operating systems, incidentally, offer both variants, for example FreeRTOS and Femto OS (see Table).

Task control

Regardless of which form of multitasking is used, tasks must have the capability of being carried out reciprocally. After all, it makes little sense if an outputting task is initiated before the previous task has delivered the necessary data to be processed. A long-established technique makes use of the so-called 'semaphore' (think of a railway signal arm). In the simplest form we have a variable that a task updates from zero to one. The next task attempted is halted until the first task has reset the semaphore to zero. Of course the semaphore routine cannot be called directly but only by an operating system routine. If required, this also takes care of the context change. There are also a variety of other comparable mechanisms, most

of which work on the same principle.

In pre-emptive multitasking the requirement for synchronisation is naturally higher and the context change is more onerous than in the co-operative method. If the need for protection against being called by other tasks lasts only for a short duration, we can alternatively define a critical zone to forestalling a context change. This is comparable with blocking interrupts in programming without operating systems.

Almost all operating systems provide dynamic memory management. In this way the operating system can allocate memory to a task as and when required. Afterwards it can be returned for use by other tasks. Small systems that suffer notoriously from memory shortage benefit by this.

We are all bound to have lost books and ballpoints that we lent out and operating systems suffer in the same way, especially with applications written in C. For this reason in particular the developers of ChibiOS/RT (see Table) avoided the use of dynamic memory management altogether. This also circumvents a further problem that goes

by the name of memory fragmentation, in which available memory gradually suffers death by a thousand cuts and expires.

Input and output control

Input and output control is even now not fully integrated with all operating systems (previously only high-end operating systems were obliged to offer this, as the functions in question formed part of the system kernel).

In systems like Linux the kernel itself handles the entire input and output function. More basic operating systems offer little or no support of this kind. On the face of it, this is no big problem if the hardware offers relatively basic interfaces that can be controlled direct by the application. This, however, then neglects the major task of shielding the user from hardware technicalities. Generally this holds good not only for classic input/output commands but also for other hardware-dependent functions, such as reading or setting dates and the time.

In reality operating systems seldom provide direct access to the classic input/output commands required by applications but

Compatibility

Anyone planning to migrate an application from one operating system to another may encounter difficulties. Functions that are operating system-specific (initiating a task, determining priorities, etc.) may obstruct the desire for compatibility and that's putting it mildly. Any subsequent change to another system will be made more problematic. Operating systems like Nuttx or TNKernel (see Table), which are aligned towards POSIX and/or ITRON standards [7] [8] are the exception in small systems.

instead provide a so-called runtime library that links together applications and operating systems (Figure 1). These libraries are frequently sufficiently flexible to cover a substantial range of standard functions without support from the operating system, at least the standards C89/C99 [4] valid for C programs.

Processes and threads

Operating systems for 32-bit CPUs and upwards of course offer additional features. Frequently these are based on a monolithic kernel that stores and carries out applications in RAM during runtime. This allows several applications to run concurrently (multiprocessing). Using dedicated hardware known as a Memory Management Unit (MMU), application programs can be protected from one another's actions. If a flawed program attempts to seize memory from another program, it is simply isolated from the operating system. As context changing between protected processes places heavy overheads, it is alternatively possible for several tasks within a process to run quasi-concurrently in so-called threads. In this multithreading situation the threads share the process memory. It's here that

the boundaries with the familiar PC operating system become blurred. For this reason it is not surprising that in the Open Source domain for larger embedded systems Linux is the undisputed market leader.

Smaller systems generally have no ability to manage multiple processes. The operating system is generally packaged in libraries that during creation are assembled along with the application into a single binary file. Subsequently this file is loaded onto the target system and executed in a single process. Multitasking here is confined to multithreading. The missing memory protection makes it all too simple for a faulty routine to crash the complete system.

The Contiki operating system already mentioned demonstrates that remarkable results can be achieved even with minimal hardware (just an 8-bit controller). Contiki makes it possible not only to initiate processes dynamically during runtime but also even provides a GUI (graphical user interface) for this (Figure 2). A graphical display and mouse port are not absolutely necessary, as Contiki has an integrated VNC server [5] with TCP/IP support. On the PC a browser is started up that loads a Java applet

as a VNC client to represent the GUI of the embedded operating system. This even has an integrated Web browser; a double click on the corresponding icon is all you need to let you surf the Internet with your little 8-bit processor!

Development environment

To tailor small operating systems to available hardware and match their demands to the application, they need to be configured. In most cases you edit the source data (with adequately detailed documentation) on the PC and initiate a Make program or some-

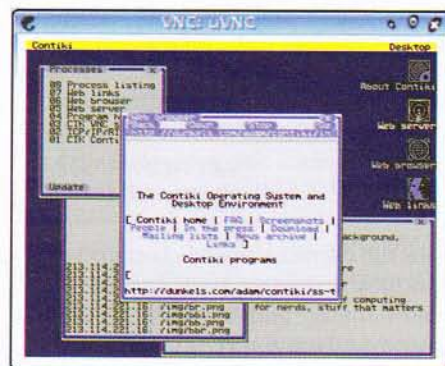

Figure 2. Contiki offers a graphical user interface (GUI), which users can control with their PC's browser program.

thing similar in order to compile a bespoke system for your own particular purposes. In some cases convenient configuration programs are supplied, such as the configuration program of the Nut/OS operating system (Figure 3) or the wizards provided with BERTOS and Helium (see Table).

Unfortunately there's no guarantee that the Compiler and Linker, as used traditionally for firmware development, will harmonise with your selected operating system.

Alternatively it may happen that the recommended development tools are not available for the particular version of your home PC's operating system. Mac OS users are all too often overlooked in this respect but even they should not be discouraged. The best course is to look for a development environment that will run under Linux.

Internet Links

- [1] www.elektor.com/090843
- [2] www.elektor.com/071081
- [3] [http://en.wikipedia.org/wiki/Reentrant_\(subroutine\)](http://en.wikipedia.org/wiki/Reentrant_(subroutine))
- [4] http://en.wikipedia.org/wiki/Standard_C_library
- [5] http://en.wikipedia.org/wiki/Virtual_Network_Computing
- [6] www.opensource.org/licenses/alphabetical
- [7] http://en.wikipedia.org/wiki/POSIX#POSIX-oriented_operating_systems
- [8] <http://en.wikipedia.org/wiki/ITRON>

These tools can be installed from available source code packages, even under OS X. In addition there are the Linux emulators Fink for Mac users and Cygwin or MingW under Windows.

When you start installing fairly large applications you will inevitably need to track down errors as well. Even with in-circuit debuggers this task can waste a lot of time, since every alteration has to be transferred onto the target system. With an adequately compatible programming interface, as in the case of Nuttx or Nut/OS, you can test your applications first on a PC. Generally only a few changes are necessary before transferring them onto the embedded system. Even handier is using a simulator, such as the one supplied for Contiki.

Licenses

In the Open Source world enthusiasts programming for their own purposes need not worry about squandering money on licences. There are limits to this freedom, however, when it comes to sharing licenses with others. The widely distributed GNU General Public License (GPL) is quite strict about this [6]. If you are using a library under GPL, any application that uses this library must be published together with the source code as well. However, the GPL does concede the possibility of appending exceptions to the original licence. For software in the embedded domain such exceptions are generally the rule, which is how people can even sell evaluation kits with Open Source operating systems like FreeRTOS (Figure 4).

With the LGPL (Lesser General Public Licence) operations that use a corresponding library can remain closed source, as long as alterations to the library are themselves left open.

The BSD Licence (BSD) is relatively indiscriminating and demands only that copyright endorsements are retained in onward distributions.

It is always worth reading and understanding licence conditions with some care, so leave adequate time for studying these texts before deciding on a particular system!

(091035)

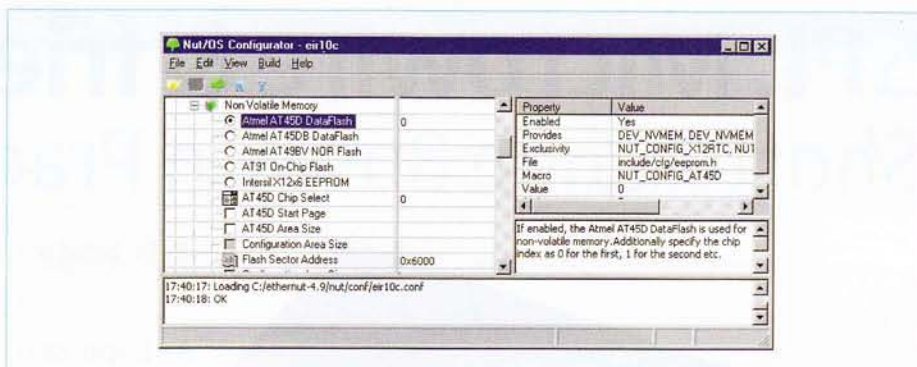

Figure 3. Configuration of the Nut/OS operating system is extremely handy.

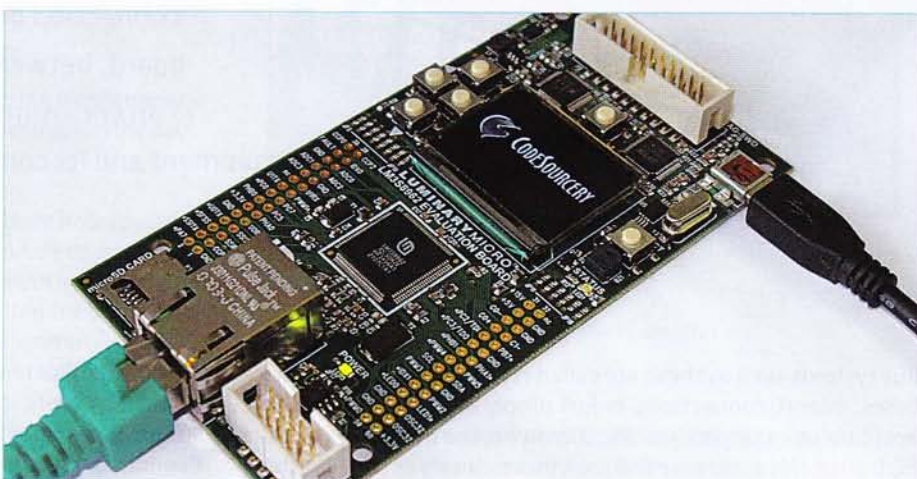

Figure 4. Users of the LM3S8962 Ethernet Evaluation Kit from the firm Luminary have the choice of either commercial operating systems or FreeRTOS, which is offered under the GPL licence.

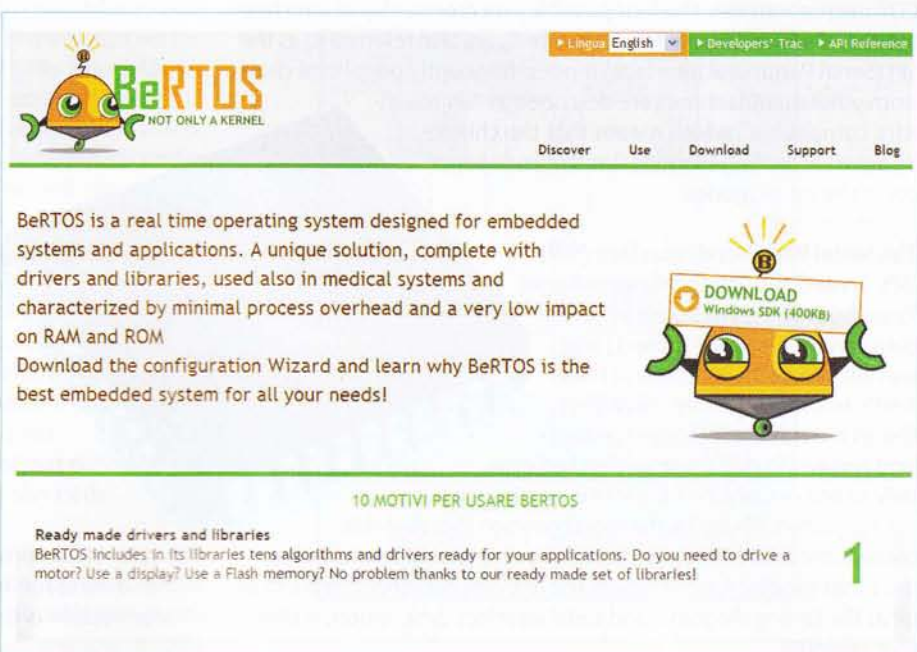

Figure 5. The homepages of operating system projects (this one is BeRTOS) are where you will find all manner of downloads, tips and tricks as well as news.

SPI, Microwire & friends

Short-Range Buses in Practice

By Dr. Bernd vom Berg and Peter Groppe

An important application of synchronous serial communications is in short-range buses, which provide a simple and reliable means of connection between ICs on a single printed circuit board, between the circuit boards or modules in an enclosure or rack, or between a piece of equipment and its control panel.

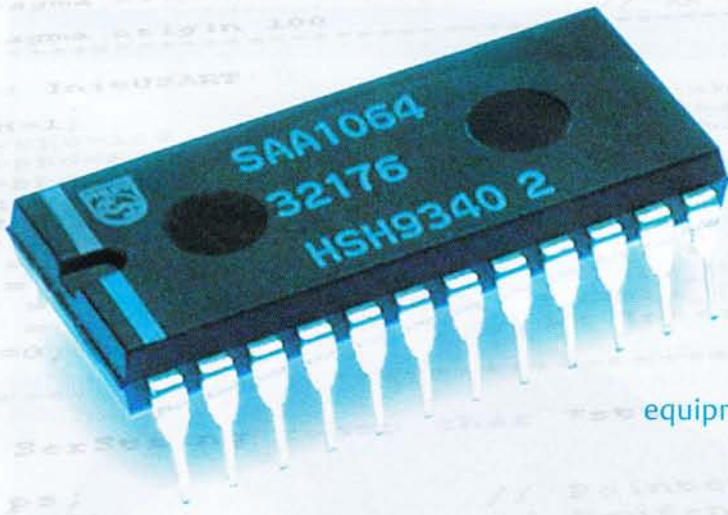

Bus systems such as these are called (synchronous) serial device buses, inter-IC connections, or just simply short-range buses. The best-known examples are SPI, Microwire, the 3-wire bus and the I²C bus. In this article we will look more closely at the first three of these.

Microwire

This synchronous serial bus was introduced by National Semiconductor as one of the first ways to connect serial peripherals to their COP microcontroller. The four possible synchronous serial interface modes, of which Microwire uses mode-0, are also referred to as the SPI (Serial Peripheral Interface) modes: frequently peripheral chips from other manufacturers are described as 'SPI/Microwire compatible', which means that the chip must be driven according to mode 0 and does not operate in the other modes.

The Serial Peripheral Interface (SPI)

'SPI' is used as an umbrella term for all four modes of synchronous serial data communication (Table-1) and was introduced by Motorola in their 6805 microcontroller. However, things are not completely standardised and an SPI chip must be checked carefully to find out which of the four operating modes are supported. Mode 0 is the most common (because it is compatible with Microwire) but many chip manufacturers also use other modes. A close look at the relevant datasheet, in particular at the timing diagrams and serial interface description, is therefore essential.

3-wire

In designing the 3-wire interface, shown in Figure 1, the engineers

at Maxim/Dallas reasoned as follows: when serial data transfers are examined closely, it often becomes apparent that either the master station is sending data to the slave or the slave is sending data to the master — not both at the same time. In other words, the data transfer is generally half-duplex, even when full-duplex operation would be possible.

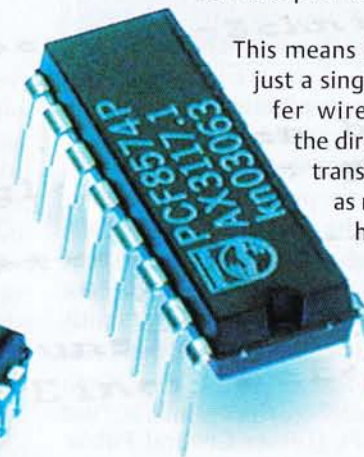
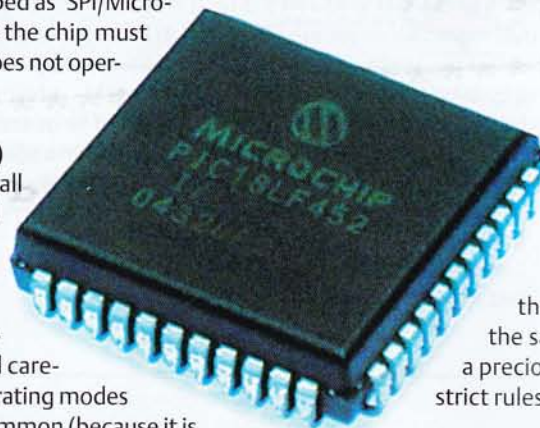

This means that we need just a single data transfer wire DQ, where the direction of data transfer is changed as necessary: we have bidirectional communication over a single wire.

Sometimes the DQ pin on the slave is an input, sometimes an output, and the same goes, of course, for the master. This saves a precious digital I/O pin at the cost of having to follow strict rules for data transfer:

1. When power is first applied the slave must always wait for a message from the master before proceeding. The slave connection is thus initially an input.
2. The master is responsible for waking the slave up. The slave can react to its wake-up call in two possible ways. If the master proceeds to send configuration settings or commands, these are

Table 1. The most commonly-used names for the serial port connections on peripheral chips.

Signal	Generic name	Motorola-specific name	Maxim/Dallas-specific name
Clock	SCLK	SCK, CLK	SCK, CLK
Transmit (master to slave)	SO/SI	MOSI: master out - slave in	DOOUT/DIN (date out/in) or DQ
Transmit (slave to master)	SO/SI	MISO: master in - slave out	DOOUT/DIN or DQ
Slave enable	\overline{CS} (chip select)	\overline{SS} (slave select)	RESET, \overline{RST} , LOAD
	Some slaves require an active-low signal for enable (\overline{CS} , \overline{SS} or LOAD), while some slaves require an active-high signal (RST).		

processed by the slave, which remains in receive mode. Alternatively, if the master asks for data, the slave will switch to transmit mode. When the transmission is complete the slave automatically returns to receive mode and waits for a new command message from the master.

The rules guarantee that only one participant on the bus tries to transmit data on the DQ wire at any one time, while the other receives the data.

Applications

A panoply of SPI chips is now available covering the whole spectrum of possible applications (Table 2). We will pick out three interesting peripheral devices from the range and look at them in more detail, and put them through their paces. We connected the chips to an 8051-series microcontroller and used software written using C51. Other microcontrollers can of course be used: SPI modules and protocol implementations are ubiquitous and thoroughly documented. Other programming languages can also be used. We have assembled a data pack, containing detailed information including data sheets and further details on the chips discussed. It is available for download from the *Elektor* website.

There are two possible ways to implement SPI on a microcontroller:

1. If the microcontroller already has the necessary interface hardware as an on-chip peripheral module, the software must set the parameters CPOL and CPHA in the relevant SFRs (special function registers). Then the data byte to be transmitted is stored in the transmit SFR and then, once the start command is issued, the data transfer is handled completely autonomously under hardware control in the SPI module. This method can achieve the highest data transfer rate.

Receive operation is equally simple. The SPI module receives the serialised bits autonomously (according to the transfer mode specified by CPOL and CPHA) and then informs the microcontroller, for example using an interrupt, when a complete byte has been assembled. The application software can then process the data byte.

The software effort required to implement synchronous serial communications in this way is minimal.

2. If the microcontroller does not have a dedicated on-chip SPI module, the synchronous serial communications protocol must be implemented using spare digital I/O port pins. The programmer must set the port pins individually high and low in software in such a way as to generate the appropriate clock signal and to ensure that the data bits are transmitted on the correct edge of the clock.

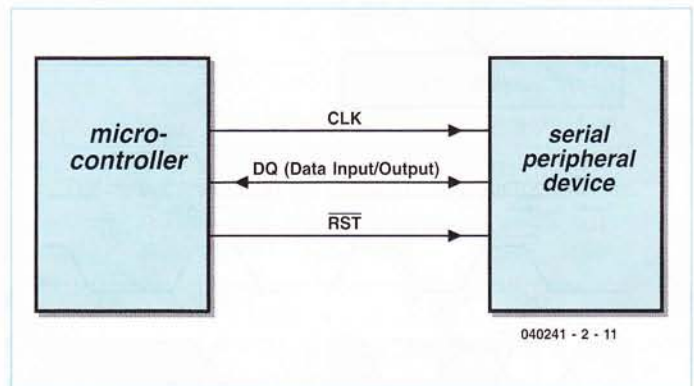

Figure-1. The 3-wire interface.

For reception, the clock must again be generated 'by hand' and the state of the input pin read in on the correct edge of the clock signal. The clock pulses and data bits must be counted exactly.

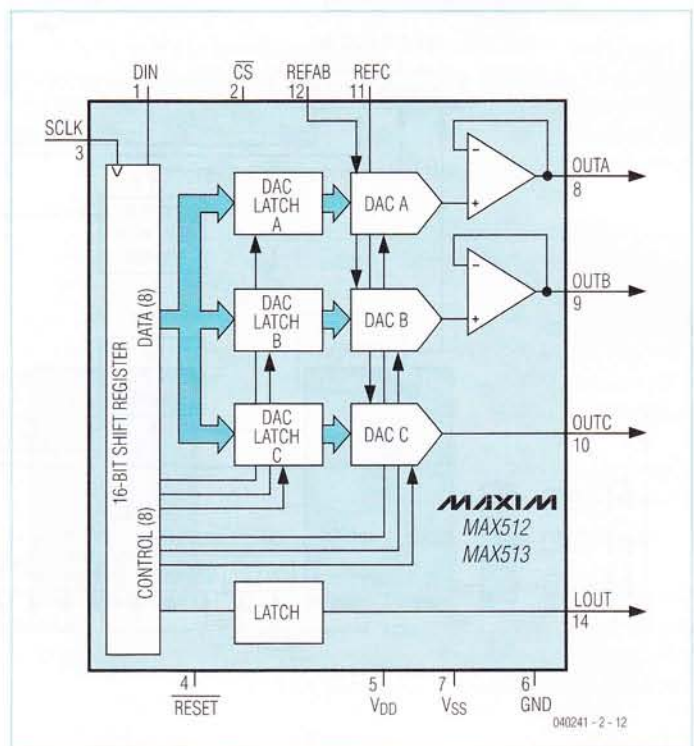

Figure-2. Block diagram of the MAX512.

SHORT-RANGE BUSES

Table 2. The world of SPI.

Data converters	A/D and D/A converters
memories	EEPROM and flash EPROM
Clock modules	Real time clocks (RTCs)
Sensors	Temperature, pressure, etc.
Display controllers	LED matrix, alphanumeric LCD
Asynchronous serial interfaces	UART
Bus controllers	CAN, USB
Miscellaneous	Digital potentiometers, digitally-controlled amplifiers, etc.

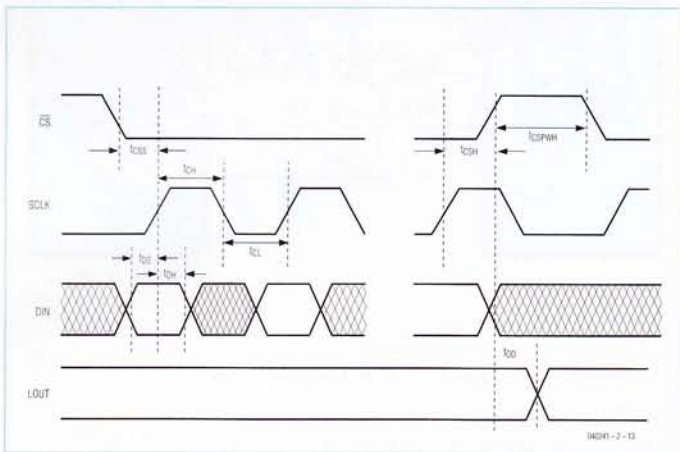

Figure-3. SPI timing diagram (SPI mode 0).

These shenanigans are called 'bit banging', where a synchronous or asynchronous serial communications interface protocol is emulated using individual port pins by setting and clearing these pins in software. Although not especially complicated to program, this method results in data communication considerably slower than that which can be achieved using an on-chip module.

Since we are working with an 8051-series microcontroller we shall have to employ the bit-banging technique since many members of the 8051 family do not offer an on-chip SPI module.

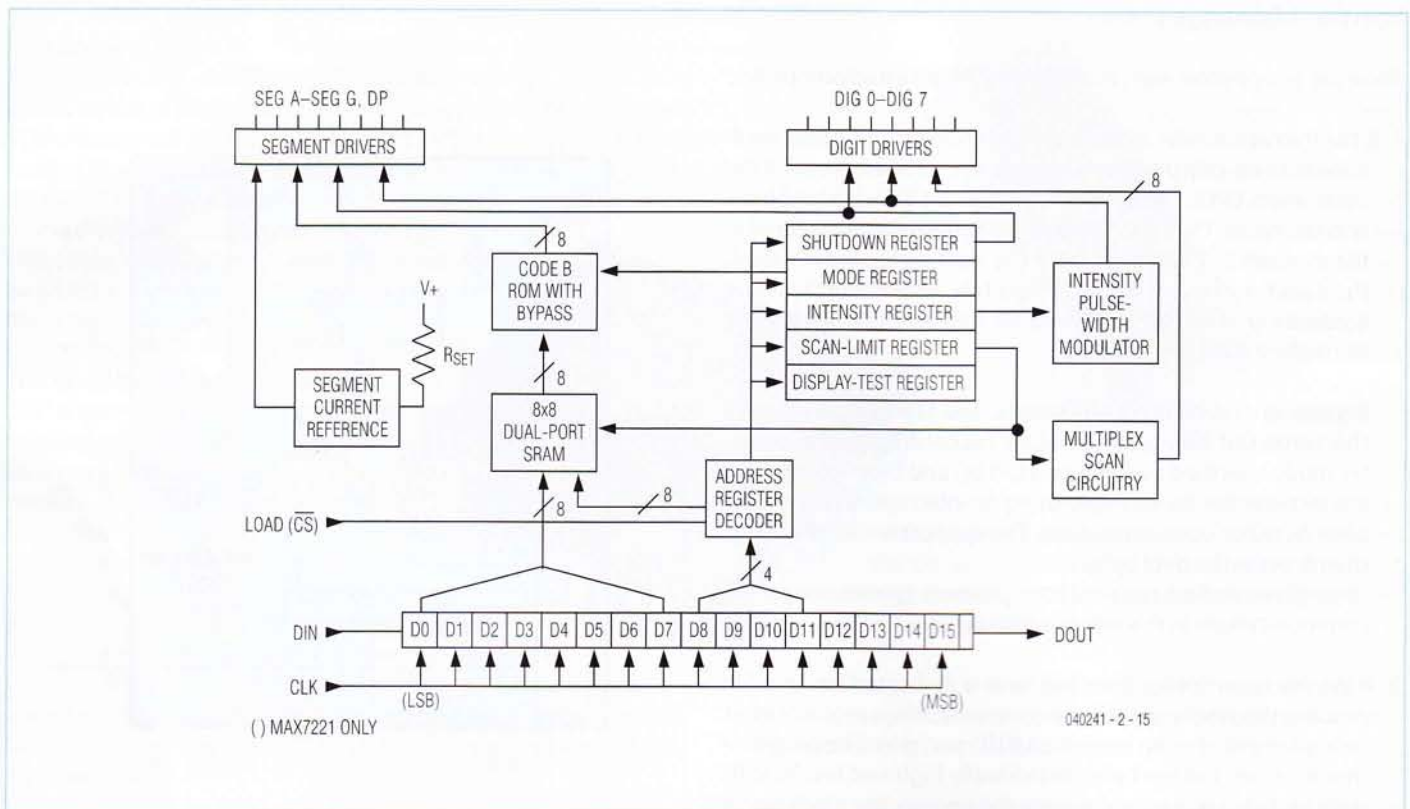

Figure-5. Block diagram of the MAX7219.

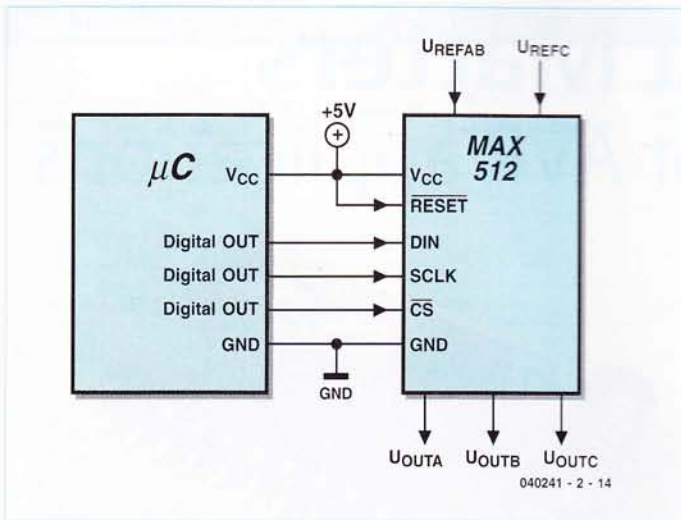

Figure-4. Connecting the MAX512 to a microcontroller.

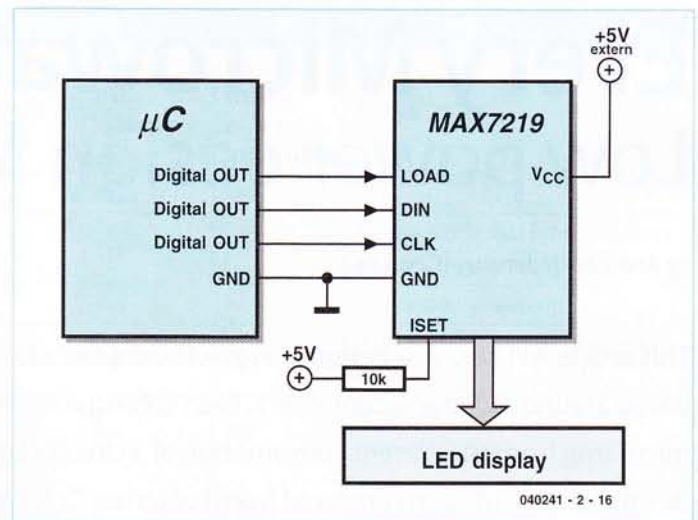

Figure-6. Connecting the MAX7219 to a microcontroller.

MAX512

Serially-controlled D/A converter

SPI mode 0 and Microwire compatible

This chip contains three D/A converters with a resolution of eight bits. **Figure 2** shows the block diagram of the device, **Figure 3** the SPI timing diagram and **Figure 4** the connections to a microcontroller.

MAX7219

Serially-controlled LED matrix display driver

SPI mode 0 and Microwire compatible, cascadable

The MAX7219 can drive up to $8 \cdot 8 = 64$ individual LED segments in multiplex operation. It also includes a BCD decoder module, and so is equally suitable for driving individual LEDs or 7-segment or 8-segment displays. The chip also has an DOUT output which makes it easy to cascade the devices to construct displays of almost any size.

Figure 5 shows the block diagram of the chip, and **Figure 6** shows how it can be connected to a microcontroller. To cascade devices, connect the DOUT pin of the first to the DIN pin of the second, and so on; the clock and load inputs are all wired in parallel.

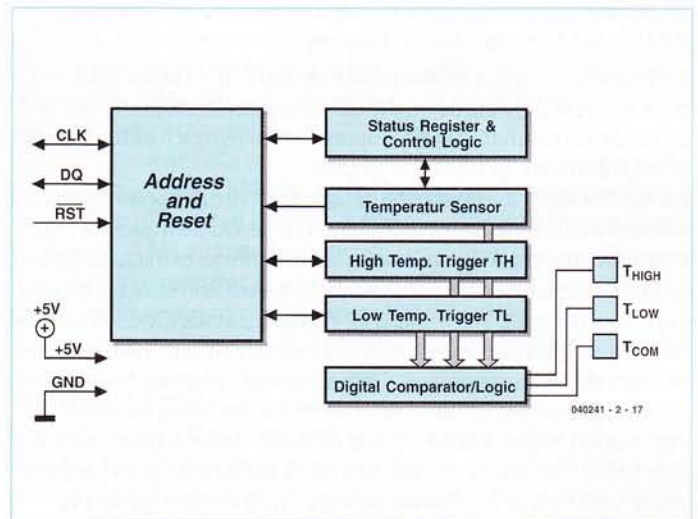

Figure-7. Block diagram of the DS1620.

DS1620

Serially-controlled thermometer

with thermostat

SPI mode 3, 3-wire interface

This device contains a thermometer, for temperature measurement, as well as a thermostat, for temperature control. **Figure 7** shows the block diagram and **Figure 8** the connections to a microcontroller.

The chip employs bidirectional communication over a single wire. First of all, the master sends a command to the DS1620 (for example, 'measure temperature now') and then the DS1620 replies with the measured value. The DQ wire is thus used in both directions, and the master must switch its I/O port pin between output mode and input mode as necessary.

(040241-2)

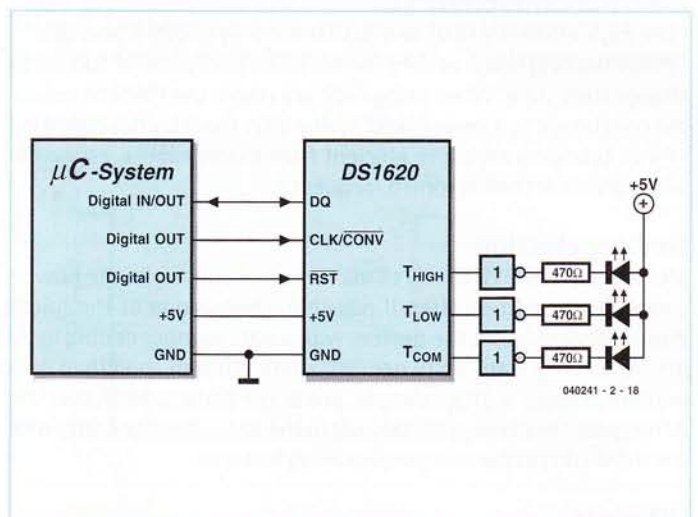

Figure-8. Connecting the DS1620 to a microcontroller.

Every Microwatt Matters

Low power design for AVR applications

By Andreas Riedenauer (Germany)

This article will help you design energy-efficient circuits based around AVR microcontrollers. Even cutting a single microamp from the current consumption of a circuit can be important in designs powered from batteries, Goldcaps, solar cells or 20 mA current-loop interfaces, and in designs that use so-called 'energy harvesting'.

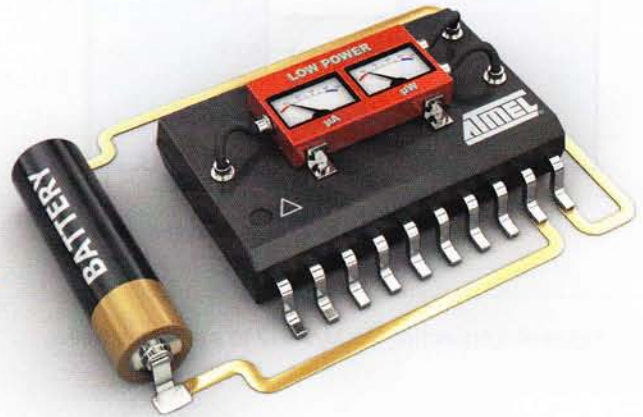

An important aspect of low power design is the consumption of a device in stand-by mode. In the UK consumer devices left in stand-by mode are estimated to be responsible for as much as ten per cent of total domestic power consumption.

Energy efficiency starts with the design of the circuit. For this article we will look at the AVR microcontroller, a firm favourite in Elektor microcontroller projects. AVRs are among the most frugal of microcontrollers in terms of absolute power consumption as well as in terms of processing power per watt. The reasons for this are its static CMOS design, its Harvard architecture and its RISC-like instruction set. The device also incorporates features such as 'Flash sampling', whereby the program memory is disabled to save power when it is not being accessed.

Application Notes AVR040^[1] and AVR042^[2] give a good introduction to the subject. They include a lot of useful advice on hardware design, with regard to power saving as well as more generally.

We will now look at some of the concrete power-saving ideas and recommendations in these Application Notes.

External components

- Use high-efficiency LEDs and flash them only briefly if possible.
- Prefer latching relays as they require just a brief pulse of current to change their state. When using ordinary relays, use PWM to reduce the coil current to a lower ('hold') value after the relay has pulled in.
- Piezo sounders are more efficient than loudspeakers, especially when driven at their resonant frequency.

Device selection

Members of the AVR family of microcontrollers vary in the power-saving features they offer. If possible, choose one of the 'picoPower' devices. Also, the devices with a part number ending in 'A' are between ten and sixty per cent more efficient than others in the range. So, for example, prefer the ATmega88PA over the ATmega88P or ATmega88. Devices in the XMEGA range come with the most comprehensive power-saving features.

I/O ports

Unused I/O port pins should be configured as inputs. All digital inputs (including unused ones) must be held at a defined logic level,

either by external circuitry or by activating internal pull-up resistors. Beware: the default situation in the reset state is that these resistors are not activated. External resistors are therefore required if current consumption during reset must be minimised. XMEGA devices also include internal pull-down resistors.

Clocking

The current drawn by an ordinary CMOS circuit is approximately proportional to the frequency at which it is clocked. For circuits that run continuously a clock frequency must be chosen high enough to guarantee that the necessary processing can be performed in time. What should be done if we do not need continuous operation but rather occasional rapid bursts of processing? In such cases we need to use the sleep modes of the processor to disconnect the CPU from the system clock for the majority of the time (or the system clock can be completely disabled). We wake the CPU up when it is required, have it perform the necessary tasks, and then return it to sleep.

Table 1 gives an overview of the various sleep modes available. In all these modes it is possible to wake the CPU up in response to an external interrupt, reset, two-wire interface (I²C) address match or watchdog event (if enabled).

If an external wake-up event, such as a button press or a signal on an interface, is to be used, then it is possible to put the AVR into power down mode. At 0.1 μ A this is the most efficient of all the sleep modes. If the processor is to wake itself autonomously, the real time clock (RTC) must be enabled. In this power save mode a picoPower AVR will draw less than 1 μ A, around one tenth of that drawn by a standard AVR device. These figures are for operation at a temperature of 25 °C and are 'typical values': in practice current draw varies from device to device.

If processing is carried out only occasionally it is better to have brief periods of activity at a high clock frequency than longer periods at a lower clock frequency. The choice of supply voltage may affect the maximum possible clock frequency, and, except in the case of XMEGA devices, the internal RC oscillator can only be used at up to half of the maximum rated clock frequency of the device.

If the length of an active period is fixed, for example by the baud rate of a UART, then the clock frequency can be reduced to the lowest

Table 1: Summary of sleep modes

Sleep mode	Main clock	RTC	Wakeup	SPM/EEPROM ready wakeup	ADC complete wakeup	RTC wakeup	Wakeup from other interrupts	Notes
Idle	On	On	Fast	Yes	Yes	Yes	Yes	
ADC noise reduction	On	On	Fast	Yes	Yes	Yes	No	As idle mode, but fewer modules active
Power down	Off	Off	Slow	No	No	Yes	No	Only external wakeup
Power save	Off	On	Slow	No	No	No	No	As power down mode, but autonomous wakeup possible
Standby	On	Off	Fast	No	No	No	No	As power down mode, but with main clock on
Extended standby	On	On	Fast	No	No	No	No	As power save mode, but with main clock on

feasible value. For computations the clock frequency should then be raised as high as possible. It is more efficient to switch between two alternative clock sources than to alter the division ratio of the clock prescaler: essentially, it is best to avoid generating higher frequencies than necessary anywhere in the device. The XMEGA range is particularly flexible in this regard: for example, it is better to clock an XMEGA device at 16 MHz by using the 2 MHz RC oscillator and the PLL than by using the 32 MHz RC oscillator and dividing it down. If the CPU and its peripherals require different clock frequencies then the master clock, from which these are derived, should run as slowly as possible (see Application Note AVR1010 [3]).

Clock oscillators

It is important to consider not just the frequency of the clock oscillator, but also its type. Different types of oscillator differ in their current consumption and in their start-up time.

If the sleep modes are to be used and frequency accuracy and stability requirements are not too demanding, the best choice is the internal RC oscillator. Quartz crystals have a number of disadvantages: they are sensitive to vibration, they take up valuable space on the printed circuit board, and they are slow to start up, which wastes energy. A crystal can take 15000 cycles before it is oscillating stably, while an RC oscillator is stable after about six cycles. Ceramic resonators fall somewhere in between, needing 200 to 1000 cycles to start up. The accuracy of resonators is sufficient for asynchronous

serial communications, but not for long-term timekeeping. Newer AVR's sport a temperature sensor that allows the RC oscillator to be calibrated via the OSCCAL register. The final accuracy that can be achieved, about one or two per cent, is good enough for a UART. XMEGA devices are better in this regard, offering a 32 kHz RC oscillator calibrated to within 1 % over the entire range of operating voltages and temperatures.

If crystal accuracy is a requirement, then energy can be saved by programming the CKSEL fuses to 'low power crystal oscillator' rather than 'full swing crystal oscillator', although this increases the circuit's EMC susceptibility.

If a suitable permanent clock source is already available elsewhere in the circuit, using this is the most efficient option.

Table 2 gives an overview of the various oscillator types.

Supply voltage

Current consumption is approximately proportional to supply voltage. The minimum supply voltage for most modern AVR's is 1.8 V, and for the XMEGA range it is 1.62 V. The lower the supply voltage, the lower the maximum permissible clock frequency. The ATtiny23U and ATtiny43U include a step-up converter that allows operation from a single cell. Reliable start-up is possible at 0.9 V and above, which means that almost all the energy in the battery can be used. Below 0.6 V the entire chip is switched off, in the interests of preventing a very deep discharge of the cell. The step-up converter

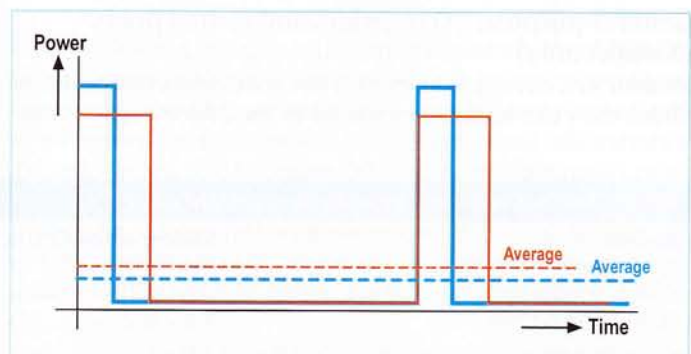
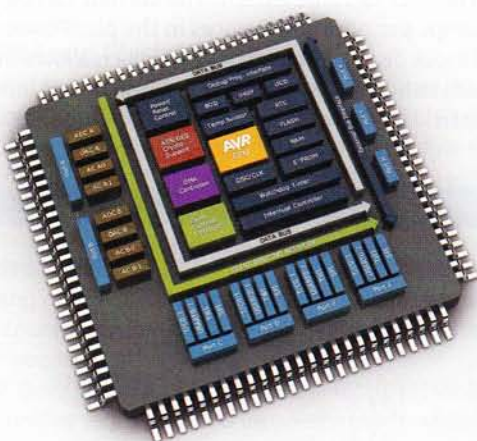

Figure 1. Brief bursts of rapid activity reduce average current consumption.

Table 2. Oscillator types

Oscillator type	Accuracy	Start-up time in cycles
Quartz crystal	10 ppm to 50 ppm	16000
32 kHz watch crystal	10 ppm to 50 ppm	16000 to 32000
Ceramic resonator	0.5 % to 1 %	200 to 1000
RC oscillator	1 % to 2 % (calibrated)	6
External clock	-	6

itself draws 17 μA , and so this may not be the ideal solution in applications where a timer must run continuously.

Brown out detection

If the battery voltage falls below a certain level the microcontroller will no longer operate reliably. To avoid this, a voltage monitor called a brown out detector (BOD) is provided, which will put the microcontroller into its reset state if the supply voltage falls below a threshold value. The picoPower AVR^s (apart from the ATmega169P and ATmega169PV) have a 'sleeping BOD' or SBOD, which can be turned off in sleep mode. When powered from a battery the supply voltage falls very slowly indeed and can be monitored using an ADC input or an analogue comparator. This can be used to warn of a low battery well before the BOD threshold is reached.

Power reduction register (PRR)

Peripherals should be shut down when not in use. Many AVR^s have a power reduction register (PRR) for this purpose. By setting appropriate bits in this register the timers, ADC, USART and two-wire interface (I²C) can be disconnected from their clock source, remaining in their last state until the clock is re-enabled. A further step, setting the ACD bit in the ACSR register, is needed to switch off the analogue comparator, saving around 60 μA at 3 V. The AC interrupt must first be disabled, by clearing the ACIE bit in the ACSR register, as otherwise an interrupt can inadvertently be triggered when the comparator is switched on or off. If the bandgap diode (generating V_{ref}) is internally connected to a comparator input, it adds a further 15 μA to the current budget, even in sleep mode. In this case it is therefore also important to clear the ACBG bit of the ACSR register. The savings that can be achieved by switching off various peripherals are outlined in Table 3.

General-purpose I/O registers and virtual ports (XMEGA only)

Modern AVR devices have many more special function registers (SFRs) than can be accommodated in the address space origi-

nally planned for them. This means that the fast IN, OUT and other instructions can only be used on some of those registers, and so by carefully choosing the peripherals it is possible to save a few clock cycles. Newer AVR^s have general-purpose I/O registers which can be accessed more quickly than the SRAM area. In the XMEGA range the length of the active period can be reduced by taking advantage of virtual ports, which allow access to the DIR, IN, OUT and INTFLAGS registers of up to four ports by single-cycle data transfer and bit manipulation instructions.

Analogue-to-digital converter (ADC)

The ADC draws about 200 μA at 3 V, and so should preferably only be switched on when absolutely necessary, and even then used in single conversion mode. Enabling noise reduction mode stops the CPU during the conversion, which saves power and improves accuracy, as the ADC no longer suffers from interference arising from the activities of the CPU. Since an eight-bit conversion takes only 12 μs (as opposed to 65 μs for a ten-bit conversion), energy can be saved if eight-bit accuracy is sufficient for the application. There is no special eight-bit mode, but we can set the ADC clock rate to a suitably high value (1 MHz) and use the ADLAR bit to ensure that the more significant result byte will appear in the ADCH register. Twelve microseconds after the conversion is initiated, this register can be read and then the ADC switched off.

Digital input disable register (DIDR)

All the AVR's analogue inputs can also be used as digital I/Os. When an analogue voltage is applied to an input, significant leakage currents can flow in the digital input stages, as both transistors in the circuit conduct to some extent. The current can be in the tens of microamps per port pin. Devices in the picoPower range have a 'digital input disable register' (DIDR) which allows the digital input circuits to be disconnected from the analogue inputs on a pin-by-pin basis.



Table 3. Savings achieved by switching peripherals off

Module	Saving when CPU active	Saving when in idle mode
USART	2 %	6 %
Asynchronous timer (RTC)	4 %	15 %
Timer/counter	2 %	6 %
ADC	4 %	14 %
SPI	3 %	11 %

Dynamic clock switching in a remote keyless entry example application

For the design of an electronic radio key we selected a classic ATmega128 device, as picoPower AVRs with 128 kbyte of Flash were not readily available at the time. Today a more economical ATmega1284PA or ATxmega128A1 would be chosen, but the principles remain the same.

The key transmitter spends 98 % of its time in power down mode; for testing purposes we activate it once per second by pressing a button. The power supply voltage is 3 V. Communication with the base station is by radio and is encrypted using AES; the data rate is 9600 baud. Data processing, including encryption, requires about 100 000 clock cycles, and each transmission consists of eight bytes.

First we try using the internal RC oscillator at its maximum frequency, 8 MHz. This gives a total energy use of 259 μJ (micro-joules) per transmission. If the clock frequency is reduced to 1 MHz, we save some power during the actual transmission, which takes a fixed amount of time determined by the baud rate. The processor also draws less current when performing the mathematical operations, but for a longer period. The overall effect is to reduce the energy use to 248 μJ , a saving of 4 % compared to 8 MHz operation. If we perform the calculations at 8 MHz and then switch the clock down to 1 MHz for transmission, we reduce the energy use still further to 207 μJ , a total saving of 20 %.

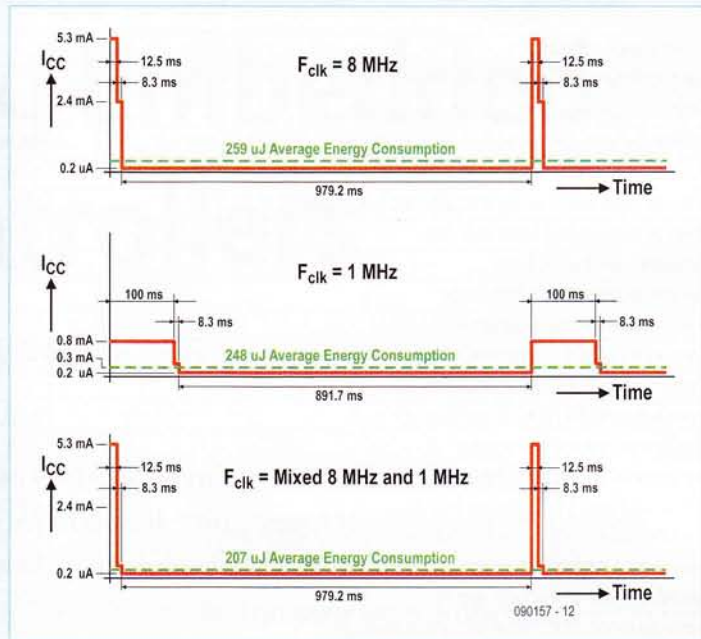

Process	Case	Clock (MHz)	Duration (ms)	Current (μA)	Power (mW)	Energy (μJ)
Calculation (active), 100 000 cycles	1	8	12.5	5300	15.9	198
	2	1	100.0	800	2.40	240
	3	8	12.5	5300	15.9	198
Transmission (idle), 8 bytes	1	8	8.3	2400	7.2	60
	2	1	8.3	300	0.90	8
	3	1	8.3	300	0.90	8
Power down	1	0	979.2	0.2	0.001	1
	2	0	891.7	0.2	0.0006	0.5
	3	0	979.2	0.2	0.0006	0.6
Total/average	1	-	1000.0	86	0.26	259
	2	-	1000.0	83	0.25	248
	3	-	1000.0	69	0.21	207

EEPROM and Flash access

The XMEGA series allows the non-volatile memory (NVM) controller to be configured to consume less power. The EEPROM and unused parts of the Flash memory can be shut down while the rest of the microcontroller is still active. It is more efficient to write to the EEPROM in page mode rather than in byte mode.

Switch off WDT and CPU

Switching off the watchdog timer (WDT) saves about 6 μA at 3 V; it is of course possible to keep the WDT enabled during development if needed.

XMEGA devices have DMA and event features, which give more opportunities to put the CPU into sleep mode while retaining the ability to react to events. For example, a data logger can run almost

entirely without CPU intervention: the RTC periodically triggers A/D conversions using the event system, and the results are transferred directly to memory under DMA. The CPU can be woken only when needed, for example if the conversion result falls outside a defined window. DMA reduces CPU use by 96 % during SPI communication at 4 Mbps and by 57 % during UART communication at 2 Mbps. An AES encryption operation can run in an XMEGA device without involving the CPU. In general, software solutions are being replaced by hardware resources, and the microcontroller should be chosen accordingly.

An important factor in current consumption is software design. Use subroutines sparingly, use fast algorithms rather than those with a small memory footprint, use look-up tables to replace slow calculations, use interrupts rather than polling, and, where possible, use RCALL

Table 4: Low power design technique checklist for AVR microcontrollers

Technique	Register	Fuses	OK
Optimise external circuitry			
Lower supply voltage		BODLEVEL	
Use picoPower/'A'-type/XMEGA AVR device			
Definite logic levels at inputs: use pull-ups	PORTx		
Define unused pins as inputs with pull-ups	DDRx		
Use sleep modes	SMCR		
Periodic operation using RTC and RC oscillator		CKSEL	
Make active period brief and fast	CLKPR	CKDIV8	
Dynamic clock switching	CLKPR		
Use low power oscillator mode		CKSEL	
Short oscillator start-up time		CKSCL/SUT	
Use sleeping BOD or turn BOD off	MCUCR	BODLEVEL	
Turn on-chip debugger (OCD) off		OCDEN	
Turn DebugWIRE/JTAG interface off	MCUCR	DWEN/JTAGEN	
Use power reduction register	PRR		
Use general-purpose I/O registers	GPIO		
Use virtual ports (XMEGA only)	VPORTx		
Use EEPROM/Flash power reduction mode (XMEGA only)	CTRLB (EPRM/FPRM)		
Disconnect digital path on inputs used for ADC and comparator	DIDR		
Use ADC noise reduction mode	SMCR		
Use only eight ADC bits if accurate enough	ADCSR(A), ADMUX		
Turn analogue comparator off	ACSR		
Turn bandgap diode (Vref) off	ACSR, ADCSR(A)	BODLEVEL	
Turn watchdog timer (WDT) off	MCUSR, WDTCSR	WDTON	
Use event system and DMA (XMEGA only)	see datasheet		
Check LCD waveforms and use low frame rate	LCDCCR, LCDFRR, LCD CRA, LCD CRB		
Use hardware resources rather than software			
Optimise software for speed; use assembler if necessary	GPIO		

rather than CALL and RJMP rather than JMP. Keep frequently-used values in working registers. If programming in a high-level language, compiler optimisation options can help produce faster code. This question is examined in more depth in an Atmel white paper [4].

LCD

Some AVR's feature an LCD controller. To minimise its current consumption, special drive waveforms are selected and the frame rate is set as low as possible. The details are given in the device datasheet under 'Minimising power consumption' and 'Low power waveform'. Using a synchronous LCD clock allows the LCD module to operate in idle and power-save modes; using an asynchronous LCD clock also allows operation in ADC noise reduction mode.

In conclusion

The remarks above are summarised as a checklist in **Table 4**. If all the suggestions are implemented it is theoretically possible, for example, to make a temperature monitor that transmits a reading every 30 seconds over a Zigbee radio network run for ten years on two AA

cells. The calculation includes the current drawn by an AT86RF212 or AT86RF231 radio transceiver. Indeed, it may be difficult to find a battery with a shelf life as long as ten years!

(090157)

Internet Links

- [1] AVR040 - EMC Design Considerations: www.atmel.com/dyn/resources/prod_documents/doc1619.pdf
- [2] AVR042 - AVR Hardware Design Considerations: www.atmel.com/dyn/resources/prod_documents/doc2521.pdf
- [3] AVR105 - Power Efficient High Endurance Parameter Storage in Flash Memory: www.atmel.com/dyn/resources/prod_documents/doc2546.pdf
- [4] 'Innovative Techniques for Extremely Low Power Consumption with 8-bit Microcontrollers' by A.M. Holberg and A. Saetre (Atmel white paper): www.atmel.com/dyn/resources/prod_documents/doc7903.pdf

About the author

Andreas Riedenauer studied electronic engineering at the Technical University of Dortmund and at the Hagen distance learning university, both in Germany. He is currently a Field Applications Engineer for Atmel distributor Ineltek and also works as a visiting lecturer, technical author and seminar leader (including for the Elektor AVR workshops). His interests, besides microcontrollers, include energy harvesting, RFID, neural networks, autonomous robots, image processing, capacitive touch interfaces, cryptography and product piracy prevention. In his spare time he is a keen glider pilot.

DISTANCE LEARNING COURSE

NEW

Programming Embedded PIC Microcontrollers

→ using Assembly, C and Flowcode

In this course you will learn how to program an embedded microcontroller. We will start with the absolute basics and we will go into a lot of detail. You cannot learn about software without understanding the hardware so we will also take a close look at the components and schematics. At the end of the course you will be able to design your own embedded applications and write the appropriate software for it.



Contents:

- Background
- Digital Ports
- Serial Communication (RS232)
- Analog Signals
- Pulse Width Modulation
- Timers/Counters/Interrupts
- Memory
- LCD Display
- I²C Communication
- SPI Communication
- USB Communication
- Configuration (Fuses)
- Answers to the assignments
- Appendix

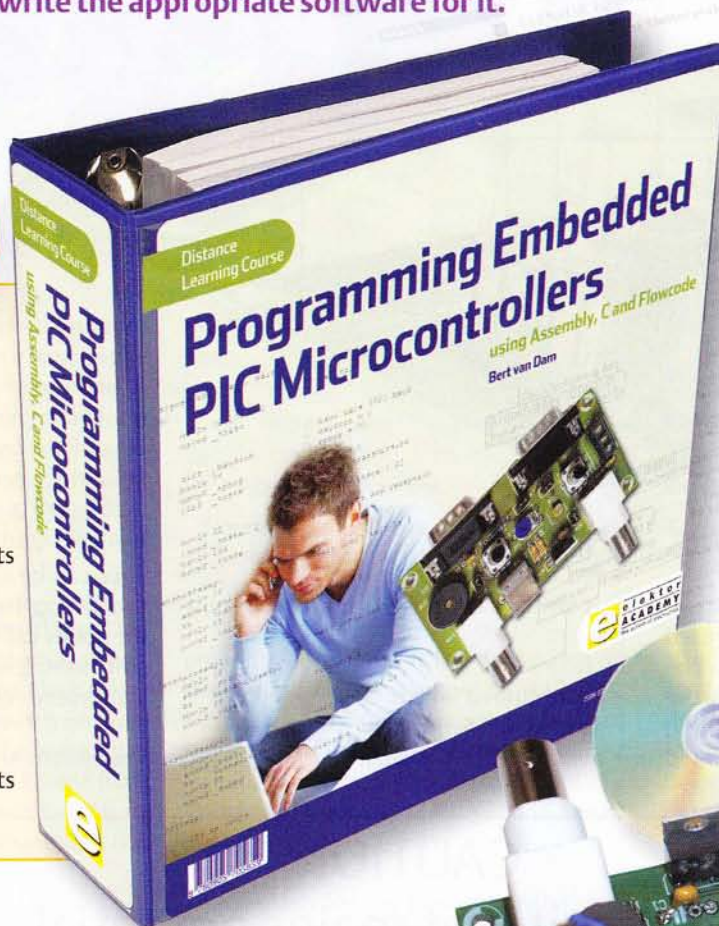

Your course package:

- Courseware Ring Binder (747 pages)
- CD-ROM including software and example files
- Application Board
- Support at Elektor Forum
- Elektor Certificate

Price: £395.00 / \$645.00 / €445.00

Please note: to be able to follow this course, E-blocks hardware is required which you may already have (in part). All relevant products are available individually but also as a set at a discounted price. Please check www.elektor.com/distancelearning for further information.



Further information and ordering at
www.elektor.com/distancelearning

Multi Function Switch

Smart Switch for power line AC

Peter de Bruijn (The Netherlands)

With this smart switch you can turn mains-powered devices on and off easily and conveniently. Applications such as TVs, radios, basement and outside lights and the like come to mind. Thanks to various sensor options this can also be done automatically or with a delay. In addition, this circuit also helps to save energy.

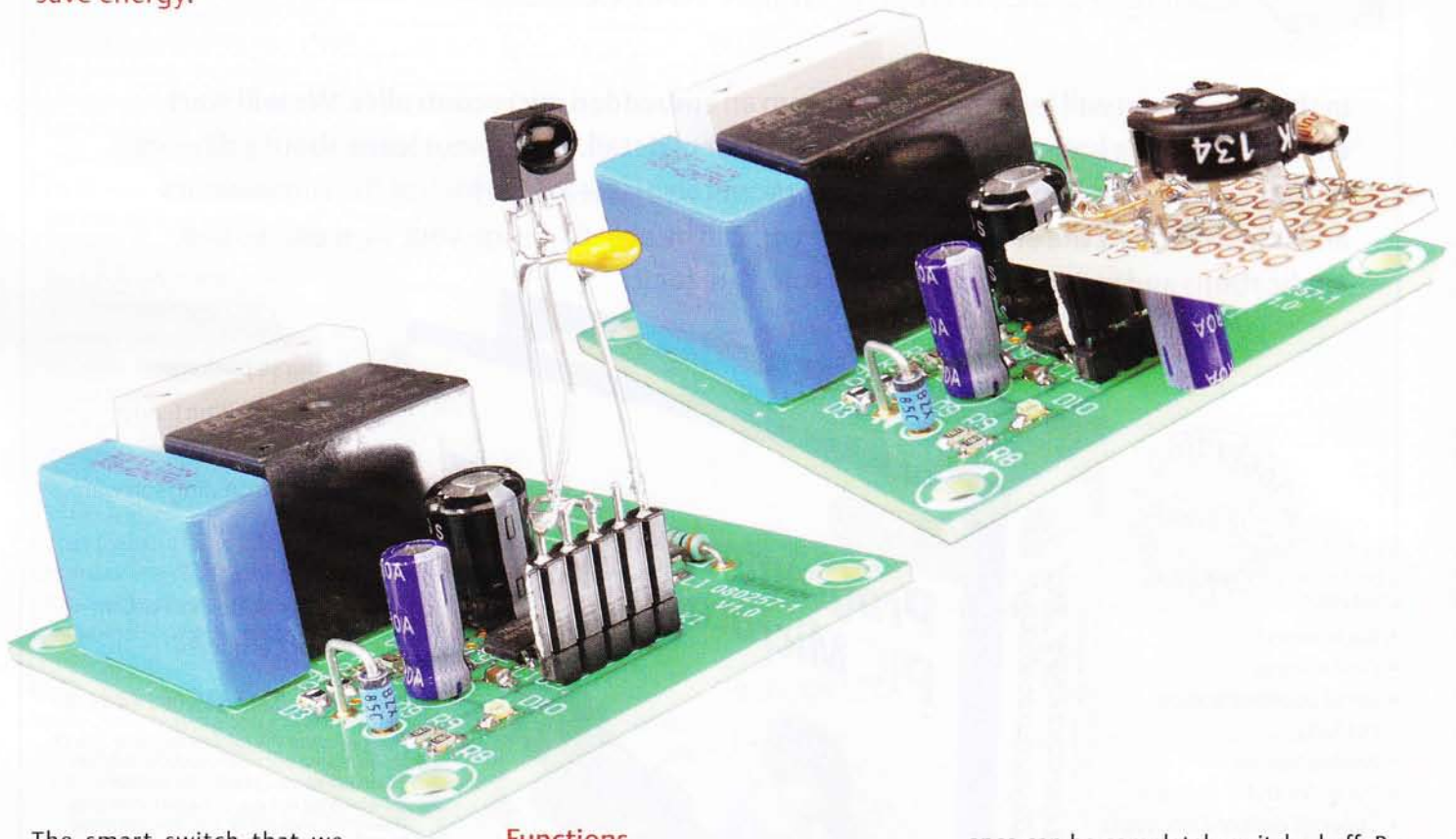

The smart switch that we describe in the article is a 230-VAC or 110/115/127 VAC switch which can be used for many different applications. This can be achieved without needing to change the software for each individual application. There is a 5-pin connection on the printed circuit board where the IR receiver, the LDR, etcetera, can be connected. It is also possible to program the processor via these pins. The 'green' smart switch saves power because in any of its configurations the load is completely disconnected from the mains after a certain time, so that the stand-by power consumption is minimised. Its simple operation completes the design.

Functions

This switch can be used in three different ways:

- as an Infrared Switch,
- as a Twilight Switch or
- as a Countdown Switch.

ance can be completely switched off. By connecting the infrared switch in series with the power cable, the TV can be completely switched off, without having to sacrifice the convenience of the remote control.

The system is very simple and works with any remote control. If a button on the remote control is pressed for longer than 0.4 seconds the TV will be turned on and you can zap to your heart's content. When in the on-state and a button on the

remote control is pressed for longer than one second, the infrared switch will turn the TV off. The TV is completely disconnected from the mains so there is a reduced risk of

CAUTION

The circuit is at mains potential

The first function, the infrared switch, is very useful if you have, for example, a TV which can only be switched 'off' into the stand-by mode. With the aid of this circuit the appli-

short circuits and therefore increased safety in the home

The switch will also turn the appliance off when there has been no activity for more than 8 hours; that is, when the circuit has not detected an infrared signal for more than 8 hours.

When used as a twilight switch, the circuit is suitable for garden or porch lights which have to be turned on and off automatically. The twilight switch has its own function that adapts to the changing seasons. To do this, the circuit measures the duration of darkness and uses 1/3 of this as the switching time. In April, for example, it is dark at 8:30 pm and it becomes light again at around 7:00 am. It is therefore dark for 10.5 hours, 1/3 of this is 3.5 hours. The circuit will therefore turn the lamp off 3.5 hours after 8:30 pm (at midnight, in other words). In October it gets dark around 7:00 pm and it becomes light again around 8:00 am (so there are 13 hours of darkness). A lamp connected to the circuit will therefore turn off at about 11:20 pm.

As a countdown switch the circuit may be used, for example, to turn on a lamp in the basement or shed, a pump for a pond, a coffee machine, a clothes iron or fan for a period of time. Pressing the switch once turns the power on for one hour, pressing twice for two hours, etcetera. By holding the button for a long time the power can be turned off.

The LED shows you how long the switch will be on for. When the countdown switch is turned on there will be one flash every second; this means that the switch will turn off in less than one hour. If the button has been pressed twice then the LED will flash twice. This means that the switch will turn off in less than 2 hours (the maximum is 3 hours).

The schematic

The smart switch is an astonishingly simple design. The most important component is the PIC10 microcontroller, which can be accessed via K1 (see Figure 1).

As already mentioned, the switch can be used in different configurations. Certain

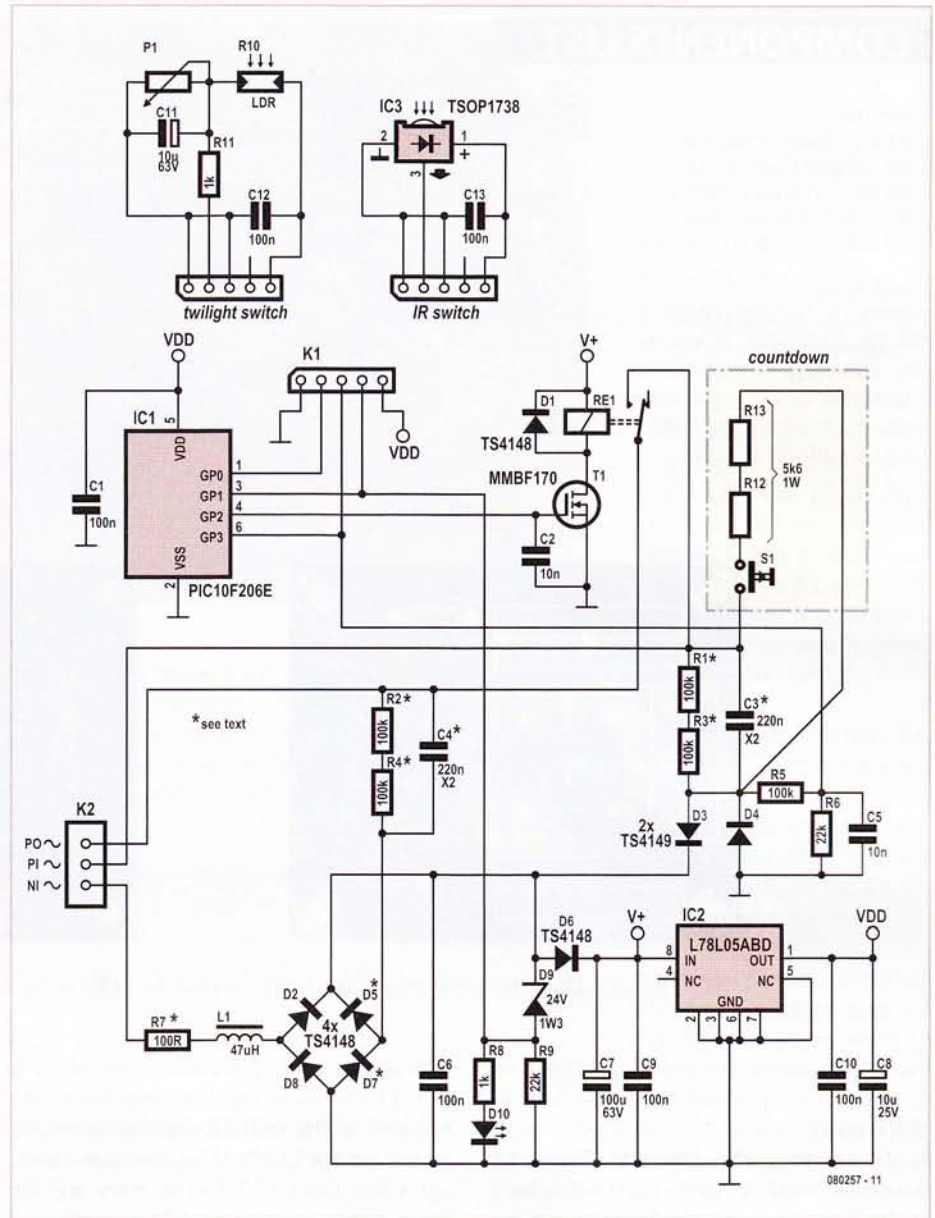

Figure 1. The smart switch can be used in three different ways. The daughter boards are connected to K1 and the modifications for the countdown switch are in the yellow box.

components are not fitted depending on the application. For example, S1, R12, R13, R2, R4, C4, D5 and D7 are not fitted when the switch is used as an infrared or twilight switch. When the switch is to be used as a Countdown Switch then R1, R3 and C3 must not be fitted.

The sensors for the twilight switch and infrared switch are connected to the circuit via connector K1 (see Figure 1).

The power supply for the circuit is derived directly from the 230-VAC or mains voltage. R7 has to be adapted for 110-127 VAC use. Rectification is done with a few diodes

after which a zener diode limits the voltage so that it does not exceed the rating for the 7805. The latter regulates the voltage for the microcontroller to 5 V. LED D10 has been added to the circuit to indicate that the circuit is powered up.

The output of the PIC cannot deliver sufficient current to drive the relay (Re1) directly. This relay is used to turn the power to the external device on and off. That is why the relay is driven via MOSFET Q1. The free-wheeling diode D1 prevents the back-emf that is generated by the coil in the relay from damaging the circuit and the MOSFET in particular.

COMPONENTS LIST

Resistors

R1-R4 = 100kΩ (SMD 1206)
 R5 = 100kΩ (SMD 0805)
 R6,R9 = 22kΩ (SMD 0805)
 R7 = 100Ω (through-hole)
 R8 = 1kΩ (SMD 0805)

Inductors

L1 = 47μH, e.g. Panasonic ELJFA470JF (1210 suppressor coil, min. 80mA)

Capacitors

C1,C6,C9,C10 = 100nF (SMD 0805)
 C2,C5 = 10n (SMD 0805)
 C3,C4 = 220nF 275VAC X2
 C7 = 100μF 35V radial

C8 = 10μF 35V radial

Semiconductors

D1-D8 = TS4148
 D9 = 24V 1.5W zener diode
 D10 = LED 0805
 T1 = MMBF170
 IC1 = PIC10F206T-I/OT
 IC2 = L78L05ABD

Miscellaneous

Re1 = 24VDC relay, SPST, Multicomp type HRS4-S DC24V
 K1 = 5-way SIL pinheader
 K2 = 3-way PCB screw terminal block, lead pitch 7.5mm

With the Twilight and IR switch, components R2, R4, C4, D5 and D7 are omitted

Twilight switch

R10 = LDR FW200, Conrad Electronics # 183580
 R11 = 1kΩ
 P1 = 250kΩ
 C11 = 10μF 63V
 C12 = 100nF

IR switch

IC3 = IR switch, TSOP1738
 C13 = 100nF

Countdown switch

(R1,R3 and C3 omitted)
 S1 = pushbutton, 1 make contact (see text)
 R12,R13 = 5kΩ 6V

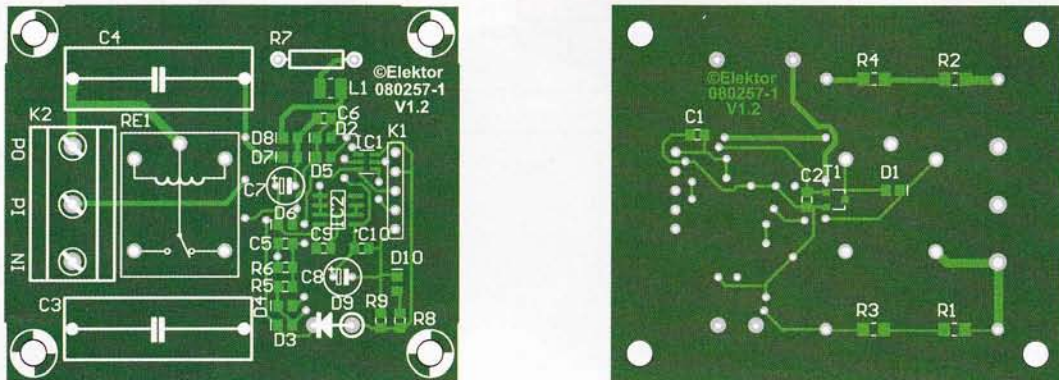

Figure 2. Most components are SMD parts so that the PCB can be as compact as possible.

Hardware

As you can see in the schematic (Figure 1), the circuit is built around a PIC10F206 (here in the form of a minuscule small outline transistor, that is, SOT-23 package). This simple microcontroller has only 6 pins, two of which are used for the power supply. The four remaining pins (GP0 through GP3) are used to drive the LED and sense the 25 V supply (GP1), driving the relay (GP2), S1 and sensing the 50 Hz or 60 Hz (GP3) and an additional optional input which is used in the twilight switch mode to prevent the lamp from continually turning on and off.

Before the microcontroller turns the relay on, it first checks via GP1 whether the voltage is high enough (>24 V). When the relay is turned on this voltage will drop down to 12 V. This is sufficient to keep the relay energised. It is possible that switching the relay on causes the processor to be reset. This is

because of the sudden application of the mains voltage to PO. This generates a voltage spike. Even if R2, C4, etcetera are not fitted, the processor will still be reset.

To overcome this problem, the software keeps track of which state the processor is in. A reset is recognised after which the processor nevertheless continues in the correct

can be programmed via K1 with, for example, an ICD2-programmer or a Microchip PICkit 2. The required connections are GND, PGD, VPP, PGC and VCC. There is no need for an external power supply when programming.

If there are enthusiasts among you who would like to use the circuit for some other application, then you will have to change the software via this interface yourself. The PIC10F206 is very sensitive to ESD. Make sure that you place C1 as close as possible to IC1.

Operating modes		
GP0=X	GP3=1	Countdown mode
GP0=<100 ms Low	GP3=0	Infrared mode
GP0=>100 ms Low	GP3=0	Twilight mode

state. The functionality of the smart switch is therefore not affected by the reset. If you intend to use the circuit as a twilight or infrared switch, you will have to add a little daughter board to connector K1. This connector, in addition to functioning as the expansion connector, also serves as programming interface: the PIC10F206

Software

The design of the software is very simple, but can nevertheless be confusing because it appears that three programs are running simultaneously. The entire program just fits inside the 512 bytes that are available in its program memory. As already discussed, there are 3 functions implemented in the software: IR switch, twi-

light switch and countdown switch. The program operates in the following order:

- Initialisation;
- ESD recognition;
- Mode selection;
- IR switch, twilight switch and countdown switch.

The software automatically makes a selection between these three programs depending on what is connected to K1.

When the circuit is first turned on the signal on GP3 is checked first:

- if the signal is High for 15 ms during the first 100 ms then countdown mode is selected. Once in countdown mode the circuit will stay in countdown mode until a reset occurs.
- if the signal is Low after 100 ms and if it has not been High for 15 ms during these 100 ms then the software will switch to infrared mode.

Once in infrared mode the software can choose whether twilight mode needs to be selected. To do this, the software checks the signal on GP0. If GP0 is Low for more than 100 ms then the circuit will switch to twilight mode. Once in twilight mode the circuit will stay in that mode. In infrared mode GP0 will never be Low for more than 100 ms because the serial communication signal from the remote control to the TV consists of pulses that are a few ms long at the most. The signal from the twilight LDR will never be shorter than 100 ms because of the electrolytic capacitor C11 (10 μ F) that was added for hysteresis.

Note that pin GP1 checks whether at least 24 V is available. Only then can the relay be switched on. At a mains voltage of 230 VAC the volt-

age available to the 5-V regulator will drop to 12 V when the relay is turned on. This is more than enough to keep the relay energised and also saves power. The switching threshold of GP0 is around

2 V. The recommended LDR requires that the potentiometer is set to about 80 k. The relay is switched off when GP0 is High and is on when GP0 is Low (and the voltage is > 24V).

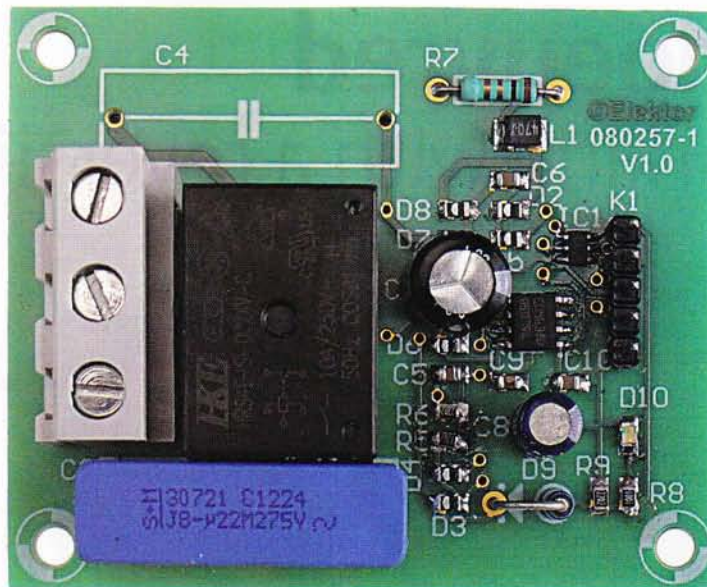

Construction

To enable the circuit to be made as compact as possible, so that it could be built into an adapter plug, for example, requires that the majority of components are SMD parts (see Figure 2). This means that the package for the PIC is very small, but because of the option of ICP (in-circuit programming) via K1, programming need not be a problem. The PCB is, incidentally, available from www.ThePCBshop.com.

When using the countdown function, R1, R3 and C3 are **not** fitted. These component locations could potentially be used to fit the two 5k6 resistors and a connection to switch S1. In IR and twilight modes R2, R4, C4, D5 and D7 may be omitted.

By the way, S1 requires special attention. For safety reasons a class II push button needs to be used here. These can, however, be hard to find and are physically quite large. A practical solution is to mount a push button inside the enclosure and attach a short plastic rod. This small rod then protrudes through the enclosure and acts as the push button actuator. It is also recommended to mount the PCB with plastic screws in a (plastic) enclosure.

A final tip: to allow the circuit to be safely tested it can also be powered from a (lab) power supply instead of directly from the mains.

(080257-1)

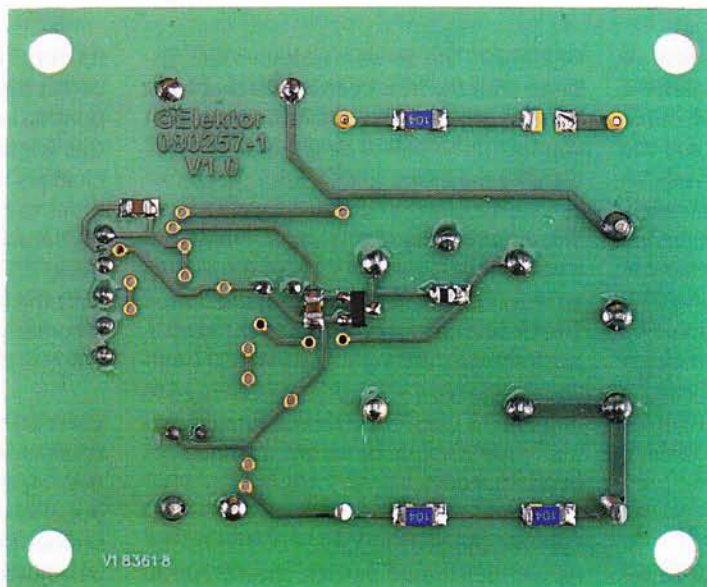

Outmanoeuvred

Perfect parking with a reversing aid



By Ton Giesberts (Elektor Labs) based on an idea by Ludovic Meziere (France)

It's not always easy to reverse a car. There are some good reasons why modern cars are often fitted with sensors that indicate when the rear bumper comes dangerously close to an object behind the car. The circuit described here is the perfect solution to make parking easier in fixed locations, such as in a garage.

Most people find it more difficult to reverse a car than drive forwards. In any case, it is much trickier to estimate how much space there is between an object and the rear bumper, and looking behind you can result in an unpleasant feeling in your neck. A solution to this problem is the reversing aid, which indicates how much further you can drive backwards without hitting anything. The circuit presented here should be mounted in a fixed position, for example on the back wall of a garage. With the help of a clearly positioned visual display you can tell if you can reverse further without crashing into a wall.

Principles

For the measurement of the distance we use a special sensor made by Sharp, the

GP2D120. The sensor measures the distance with the help of an IR LED that has a wavelength of about 850 nm. The output voltage of the sensor becomes less as the distance increases.

The visual display of this 'radar' consists of a number of LEDs that start to flash when an object comes within range of the sensor. The closer the object comes to the sensor, the faster the LEDs will flash. A VCO (Voltage Controlled Oscillator) has been used to implement this. The LEDs will turn on permanently when a minimum distance has been reached.

Circuit diagram

As we mentioned earlier, the GP2D120 (MOD1) measures the distance and reduces

its output voltage as the distance to the object (the car) becomes greater. The relationship isn't inversely proportional and neither is it linear, since the angle of reflection changes less as the distance increases. In order to properly drive the following VCO built around IC1B, the signal is first inverted using IC1A. Preset P1 has been added to shift the output voltage of IC1A such that it comes completely within the operating range of the VCO.

The VCO is turned on when T1 is made to conduct. This is easily implemented by connecting the base resistor of T1 to the output of IC1A. To make the LEDs light up continuously the output voltage of IC1A has to be adjusted with P1 to be just under 0.5 V while an object is held at the required mini-

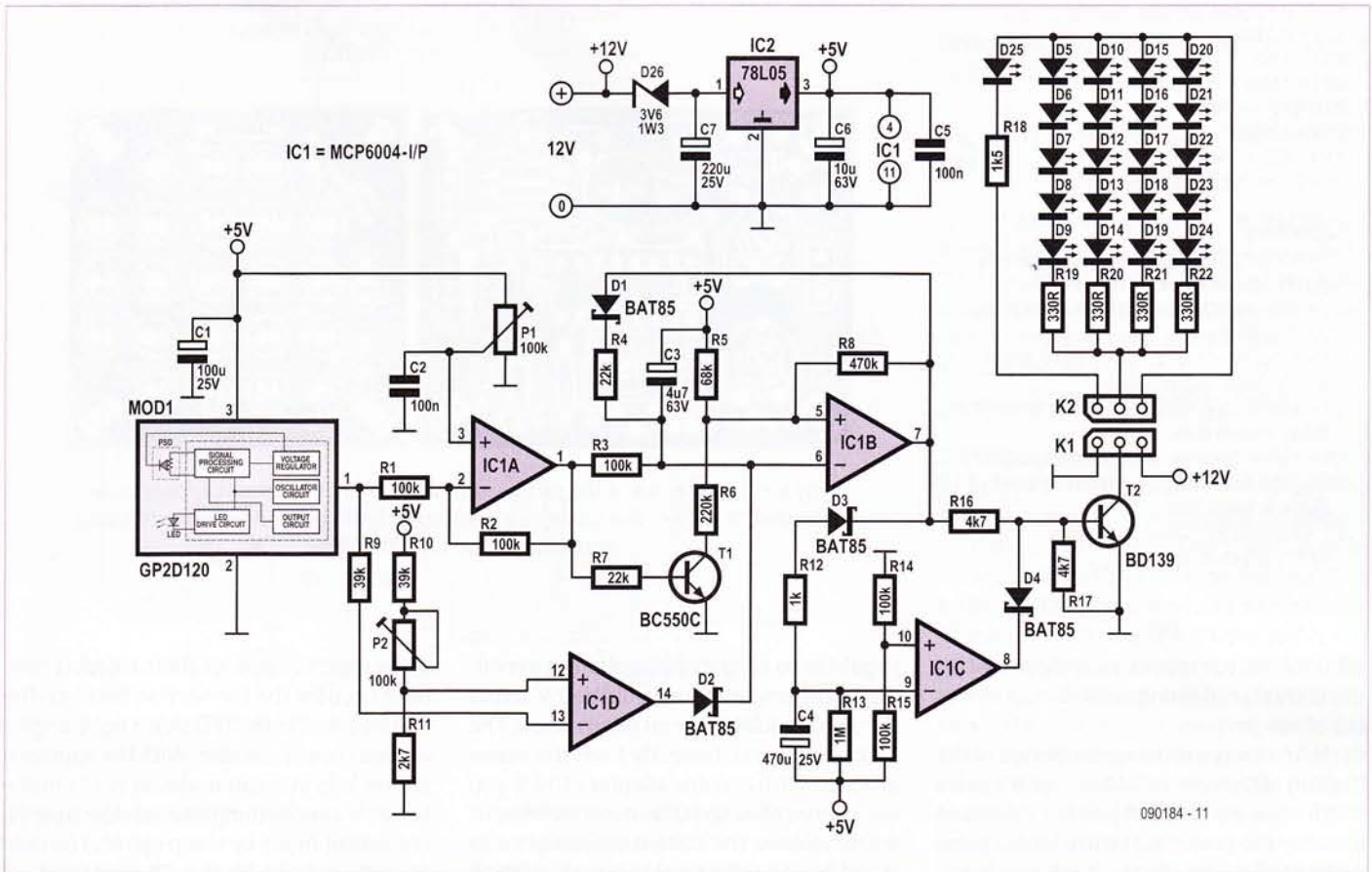

Figure 1. In the circuit diagram we can see a few 'old fashioned' applications of opamps: an inverter and a comparator.

mum distance from the sensor. The VCO is then turned off by T1 when the minimum distance is reached.

The operation of the VCO is quite straightforward. C3 is charged via R3. (We're assuming that T1 is turned on.) When the voltage at the inverting input of IC1B becomes less than the voltage at the non-inverting input, the output becomes high and C3 is discharged via D1 and R4. The threshold set by R5 and R6 determine the operating range.

R8 has been chosen such that the hysteresis is about 0.5 V. When the VCO is operating the hysteresis is between 3.4 V and 3.9 V. The maximum input voltage of the VCO is then about 3 V. With the right settings – in our prototype we set the voltage on the wiper of P1 (pin 3 of IC1A) to 1.45 V – this

covers the complete sensor output range. The VCO has been designed in such a way that the pulse width varies as well as the frequency. At higher frequencies the larger current through R3 will cause a larger current to flow through R4, which means it will take a bit longer before C3 becomes sufficiently discharged to make the output of IC1B switch state again.

The output voltage of the sensor is monitored by opamp IC1D, which is configured as a comparator. Its function is to make sure that the LEDs start to flash with a minimum frequency when an object comes within range. P2 is used to adjust the voltage across R11 between 0.1 V and 0.32 V. At the lowest setting of P2 the sensor appeared to have a range of about 1 m. That was surprisingly more than we expected because the

data sheet made us believe that the maximum range was only 30 cm (1 foot). When the voltage output of the sensor becomes too low the output of IC1D becomes high and D2 then prevents C3 from charging up. The output of IC1B will then stay low. Once the car has been parked, the LEDs stay on for about 5 minutes before they're turned off by IC1C.

IC1C is used to check if the LEDs are flashing. When the output of IC1B is low, C4 will be charged up quickly and the output of IC1C stays high, blocking D4. The LEDs will now be off in all circumstances. If the output of IC1B stays high then C4 will slowly discharge via R13. Finally, after about 5 minutes, the output of IC1C becomes low and the base current of T2 is then diverted via Schottky diode D4. The LEDs will now stay

COMPONENT LIST

Resistors

R1,R2,R3,R14,R15 = 100k Ω
 R4,R7 = 22k Ω
 R5 = 68k Ω
 R6 = 220k Ω
 R8 = 470k Ω
 R9,R10 = 39k Ω
 R11 = 2.7k Ω
 R12 = 1k Ω
 R13 = 1M Ω
 R16,R17 = 4.7k Ω
 R18 = 1.5k Ω
 R19 - R22 = 330 Ω
 P1,P2 = 100k Ω preset (Piher)

Capacitors

C1 = 100 μ F 25V, radial, lead pitch 2.5mm (0.1"), diam. 8mm max.
 C2 = 100nF MKT, lead pitch 5mm (0.2") or 7.5mm (0.3")
 C3 = 4.7 μ F 63V, radial, lead pitch 2.5mm (0.1"), diam. 6.3mm max.
 C4 = 470 μ F 25V, radial, lead pitch 5mm (0.2"), diam. 10mm max.
 C5 = 100nF ceramic, lead pitch 5mm (0.2")
 C6 = 10 μ F 63V, radial, lead pitch 2.5mm (0.1"), diam. 6.3mm max.
 C7 = 220 μ F 25V, radial, lead pitch 2.5mm (0.1"), diam. 8 mm max.

Semiconductors

D1-D4 = BAT85
 D5-D24 = LED, 5mm, red, low current
 D25 = LED, green, 5mm, low current
 D26 = zener diode 3.6V, 1.3W
 T1 = BC550C
 T2 = BD139
 IC1 = MCP6004-I/P (Farnell # 1605571)
 IC2 = 78L05

Miscellaneous

K1,MOD1 = 3-pin SIL pinheader
 K2 = 3-pin right angled SIL pinheader
 MOD1 (not on PCB) = GP2D120 (Farnell # 9707859)
 2 pcs PCB solder pin, diam. 1.3mm
 3 pcs BPH-002T-P0.5S, JST BPH-002T-P0.5S (Farnell # 3617210)
 PHR-3, JST PHR-3 (Farnell # 3616198)
 Socket for 3-pin SIL header
 PCB # 090184-1

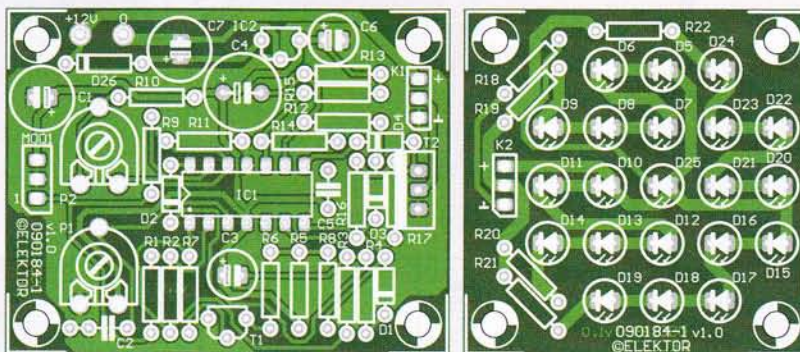

Figure 2. The layout of the relatively small boards makes them appear fairly crowded. However, due to the use of through-hole components the soldering shouldn't cause any difficulties.

off until the car moves away again, when the LEDs start flashing until the car moves out of range.

At the maximum distance the period of the flashing LEDs is about 240 ms, with a pulse width of 50 ms ($D = 21\%$). At the minimum distance the period is 160 ms, with a pulse width of 95 ms ($D = 59\%$). The change in frequency from 4 Hz to 6 Hz may not appear to be much, but the change in the duty cycle makes it much more noticeable.

Power supply and PCB

The sensor and the circuit built around the opamps are powered by a 78L05. A zener diode has been added to the input of the

regulator to keep its dissipation to a minimum. Otherwise there would be 7 V across the small regulator, for no good reason. The LEDs are powered directly from the mains adapter. With a mains adapter of 12 V you can connect five red LEDs in series without any problems. The current consumption in stand-by (no reflection) is 39 mA. With all the LEDs turned on 76 mA is drawn.

For this circuit a small single sided PCB has been designed, which consists of two parts. The PCB artwork can be downloaded from the Elektor website [1]. The LEDs have been kept separate so that they can be mounted in a clearly visible position. The sensor and the rest of the circuit can then be mounted

in the most suitable location. Headers have been used for the connection between the two boards. On the LED side a right-angled version is most suitable. With the appropriate sockets you can make an easily maintainable connection between the boards. The sensor made by Sharp can also be connected via a pin-header. The sensor itself has to be connected using a special 3-pin socket with a lead pitch of 2 mm, made by JST (Japan Solderless Terminals).

(090184-1)

Internet Links

[1] www.elektor.com/090184

Opamp choice

For the quad opamp we've selected an inexpensive rail-to-rail version made by Microchip, the MCP6004-I/P, which is perfect for this application. The opamp specifications that have to be considered for this circuit are not the bandwidth, slew-rate or output current for a change, but the maximum differential input voltage. We're using two opamps as comparators, which means that the voltage difference between the two inputs could be several volts. The opamp used here can cope with a voltage difference that is equal to the supply voltage. This supply voltage can be between 1.8 V and 5.5 V (7 V is the absolute maximum).

In many rail-to-rail opamps there are protective diodes connected in anti-parallel between the inputs, which means the maximum differential input voltage may only be 1 V. In theory our circuit could also use these opamps. For this reason R9 has been added to the inverting input of IC1D. As an example, we tried using a TS924IN. What goes wrong in this case is that the two inputs of the comparators affect each other. The time constant of C4 and R13 turns out to be lower because of the addition of R14 and R15.

Zener diode tester

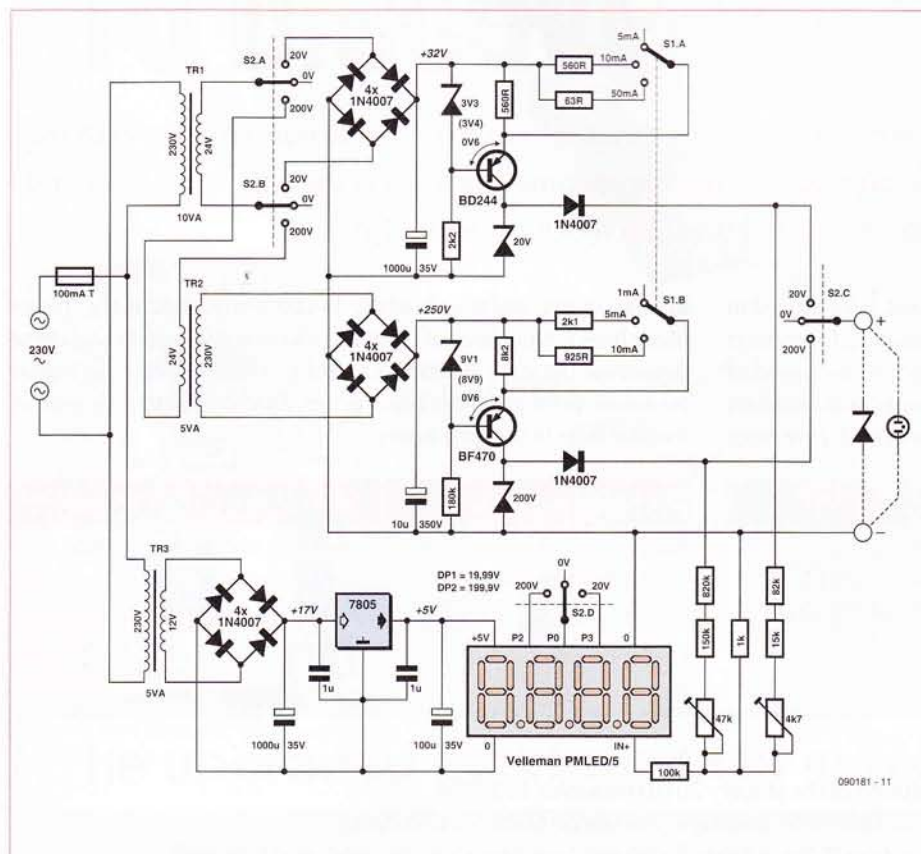

By Jean Herman (Belgium)

The instrument described here lets you check that zener diodes up to 200 V are working correctly, and it lets you find out the reverse breakdown voltage of an unknown zener diode (note that zener diodes are only called zeners from 2 V to 5.6 V — those above 5.6 V ought strictly speaking to be referred to as ‘avalanche diodes’, as the avalanche effect then becomes predominant). The voltage stability of a zener diode depends on its internal resistance and its temperature coefficient. It’s for this reason that this tester lets you measure them at various currents.

The internal resistance can be calculated from $R_{INT} = dV/dI$. The dI is achieved by subjecting the diode under test to two different currents (e.g. 10 mA and 5 mA). dI is the difference between these two currents (= 5 mA). By measuring the voltage in both cases (let’s say 6.6 V and 6.3 V), we can determine dV (6.6 V - 6.3 V = 0.3 V) and hence calculate the value of R_{INT} (0.3/0.005 = 60 Ω).

A zener diode’s temperature coefficient

depends on its reverse voltage. For a diode of less than around 5.6 V, the temperature coefficient is negative, around 5.6 V it is zero, and above 5.6 V it is positive (not for all device brands). We can determine it by measuring the voltage across the diode and the diode’s temperature with a constant current (10 mA) passing through the diode.

The device has two voltage ranges, 0–20 V and 0–200 V, which requires at least two different transformers. To generate the required voltage differences, we have three small standard transformers. Transformer TR3 is only used to provide a 5 V dc supply for the digital voltmeter module.

Switch S2 (A to D) is the 4-gang voltage range selector, and also has a central ‘off’ position.

20 V position

Transformer TR1 feeds a bridge rectifier via the 20 V position of S2.A. This produces a DC voltage of around 32 V. The BD244 transistor is wired as a constant current generator. Switch S1.A changes the emitter resistor in order to generate three different cur-

rents: 5 mA, 10 mA, and 50 mA. The current generated by the BD244 can be calculated roughly as:

$$I_{CONST} = (V_Z (3.4 \text{ V}) - V_{BE} (0.6 \text{ V})) / \text{emitter resistor}$$

A 20 V zener diode (select on test) limits the output voltage to 20 V (or if possible to 19.9 V) so as to avoid saturating the digital voltmeter. A 1N4007 diode in series with the current generator output avoids shorting out the measurement circuitry. In this case, S2.C is also in the 20 V position.

200 V position

Switch S2.A redirects the 24 V AC voltage to transformer TR2, which steps the voltage up from 24 V to 230 V. This is just an ordinary 230 V / 24 V 5 VA transformer. The bridge rectifier here produces a DC voltage of around 250 V. The BF470 transistor is also wired as a constant current generator. It’s not easy to find high-voltage PNP transistors – the BF470 is a type used as a video driver for CRTs. Here again, switch S1.B this time changes the emitter resistor in order to generate three different currents: 1 mA, 5 mA, and 10 mA (see calculation above). These currents are lower, as the diodes have a higher voltage. But at 10 mA and 200 V, that still means the BF470 transistor has to dissipate 2 W with the output shorted — i.e. for a 200 V zener.

0 V position

Note that selector S2 also has a middle position where nothing is switched.

With this device, you can also test the insulation of ordinary diode, as well as gas regulator tubes like the OA2, OB2, etc. and VDR varistors (some are polarised). The measurement accuracy of the voltmeter will give the true value of the zener voltage and the temperature drift of the device voltage.

Selector S2.D changes the module’s decimal point position between 19.99 V and 199.9 V — though the sensitivity always stays the same at 199.9 mV. Don’t forget to remove the solder bridge which is fitted by default on the voltmeter module’s P3.

(090181)

Hexadoku

Puzzle with an electronics touch

After last month's curious format using the character set 1 through G we're back to normal again with the Elektor Hexadoku challenge. Crack the puzzle, send the hexadecimal numbers in the grey boxes to us and you automatically enter the prize draw for four Elektor Shop vouchers. Have fun!

The instructions for this puzzle are straightforward. Fully geared to electronics fans and programmers, the Hexadoku puzzle employs the hexadecimal range 0 through F. In the diagram composed of 16 × 16 boxes, enter numbers such that **all** hexadecimal numbers 0 through F (that's 0-9 and A-F) occur once only in each row, once

in each column and in each of the 4×4 boxes (marked by the thicker black lines). A number of clues are given in the puzzle and these determine the start situation. Correct entries received enter a draw for a main prize and three lesser prizes. All you need to do is send us the numbers in the grey boxes.

Solve Hexadoku and win!

Correct solutions received from the entire Elektor readership automatically enter a prize draw for one Elektor Shop voucher worth £ 80.00 and three Elektor Shop Vouchers worth £ 40.00 each, which should encourage all Elektor readers to participate.

Participate!

Before April 1, 2010, send your solution (the numbers in the grey boxes) by email, fax or post to

Elektor Hexadoku – 1000, Great West Road – Brentford TW8 9HH
United Kingdom.

Fax (+44) 208 2614447

Email: hexadoku@elektor.com

Prize winners

The solution of the January 2010 Hexadoku is: 26FB4.

The E-blocks Starter Kit Professional goes to: Martin Müller (Switzerland).

An Elektor SHOP voucher goes to: Jean Philippe Poket (Belgium); Jean Pierre Vandecandelaere (Belgium); Raimund P. Neubauer (Switzerland).

Congratulations everybody!

1			3		8	D		4	E	B						
			4	6		0		F	C		3	9	A	8		
3		6	0	C	2					7	8	F	E			
8	E	B			5	4	F			9		C				
7	1				0	2	6				F	D		5	A	
	8		D	B		7		4		1	0	3			E	
2			3		D							C	4		B	
	C		B				E							1	0	8
		2			8	1		B		C	5		9	F	D	
B	7	0			6	E			A		D	8			C	
		1	8	D				7						2	A	
			E	A	F				0			5				
		3	2	5			8			0	7	1	B	9		
		9				D								4	E	
			1	7	A			9			4					
0	5		C				3	D	F	6	1				7	2

(c) PZZL.com

4	9	E	7	C	8	F	3	2	5	D	A	B	0	1	6	
1	5	2	C	9	4	A	6	0	7	B	F	E	8	D	3	
6	D	0	3	B	E	1	7	C	4	9	8	F	5	A	2	
8	B	A	F	D	2	5	0	E	3	1	6	9	7	4	C	
0	4	C	9	F	6	3	E	D	B	5	7	8	A	2	1	
B	6	F	5	4	0	8	9	A	1	2	3	C	D	7	E	
7	8	3	1	5	D	2	A	6	E	F	C	4	B	9	0	
2	A	D	E	1	7	C	B	4	9	8	0	6	3	F	5	
A	0	B	4	3	1	9	C	F	8	E	5	D	2	6	7	
D	C	5	2	6	F	B	4	7	A	3	9	0	1	E	8	
9	3	7	8	E	5	0	2	1	D	6	4	A	C	B	F	
E	F	1	6	7	A	D	8	B	C	0	2	3	9	5	4	
F	7	6	B	0	C	4	D	3	2	A	1	5	E	8	9	
C	2	9	0	A	B	7	5	8	6	4	E	1	F	3	D	
3	E	8	A	2	9	6	1	5	F	C	D	7	4	0	B	
5	1	4	D	8	3	E	F	9	0	7	B	2	6	C	A	

The competition is not open to employees of Elektor International Media, its business partners and/or associated publishing houses.

NOW, THERE'S EVEN MORE TO DISCOVER.

NEW!



The upgraded Elektor-PLUS subscription!

- All 11 issues including the Summer Circuits edition
- Included in your PLUS subscription: Annual DVD 2009
- **20%** cheaper than normal retail price
- Welcome gift worth £25
- Up to **40% discount** on selected Elektor products
- Elektor is delivered to your doorstep every month
- Read your copy before everyone else
- **NEW:** On your personalized Elektor PLUS website, you have permanent access to the three latest issues of the magazine in PDF format, as well as to a fast Elektor search engine!

NEW:
exclusive access to
www.elektor-plus.com!

When taking out an Elektor PLUS subscription you get **exclusive access** to www.elektor-plus.com where the three latest editions of Elektor magazine are available in the form of pdf files (i.e. the current issue and the two preceding ones). With a simple click you download the complete issue (front to back!) or any single article. www.elektor-plus.com also supplies the most extensive Elektor search engine found on the web. However the upgraded PLUS subscription offers many more interesting extras like free E-books and supplementary articles.

www.elektor.com/subs • Tel. +44 (0) 20 8261 4509

Or use the subscription order form near the end of the magazine.

elektor
electronics worldwide

Two Black Boxes

By Rolf Blijleven (The Netherlands)

to open. What I saw inside (**Figure 1**) reminded me of the stories of Jules Verne, from the pioneering days of electricity. It was indeed a resistor box, with a rotary switch for selecting individual values and two potentiometers. It had to be at least forty years old, but there wasn't even a trace of corrosion. Now that's quality!

It didn't take long to trace the circuit diagram (**Figure 2**), but I also wanted to know what it did, so I hooked it up and made some measurements. It turned out to be an adjustable resistor with a range of 150 to 200 ohms. The selector switch has steps of 4 ohms, and variable resistor II has a range of 6 ohms. As you can see already from the diagram, variable resistor III does not have a remarkably large range, but $60 \mu\Omega$ is rather tiny. Why was this necessary?

It took a bit of historical investigation to find the answer to this question. The larger box also proved to contain outstanding handiwork (**Figure 3**), but it was clearly a much more complex device. The conductors were not readily visible, but there were again selector switches, a sliding contact and some switches, but above all many terminal bushes. Connecting a power supply and making a few random measurements didn't seem like a good idea, but what should I do?

The label said 'Compensator'. My textbook from my technical college days said that compensators could be used to make highly accurate measurements under zero-load conditions, but they had been rendered redundant by multimeters. Google also had nothing to say on the subject, which in itself says a lot.

Finally I found the answer in a book in the technology section at De Slegte, a Dutch bookstore chain specialising in second-hand and remaindered books. It had a description of the 'compensation device', including a schematic diagram that matched the diagram of my unit (**Figure 4**). Eureka! How old was this book? I looked in the



When I first laid eyes on these two black boxes (see lead photo), I knew one thing right away: this is quality equipment, and it must be preserved. Along with a few colleagues from work, I was walking through the nearly empty building. Anyone who found something he liked could keep it; everything else was destined for the skip. I knew for sure that this wouldn't happen with these two items, but that's all I knew for sure.

The building was built in the heyday of the company, around forty years ago and far before my time. These two black boxes — only the front panel is black; the rest of the enclosure is mahogany — were in the storage area in the attic. I had never seen them before in the twelve years that I worked there.

What were they actually? They looked like adjustable resistor boxes, but why was the larger one labelled 'Compensator'? OK, a compensator compensates for something, but what, why, and how? None of my colleagues had ever used them. The only thing I could do was to open them up. I started with the smaller one, which was very easy

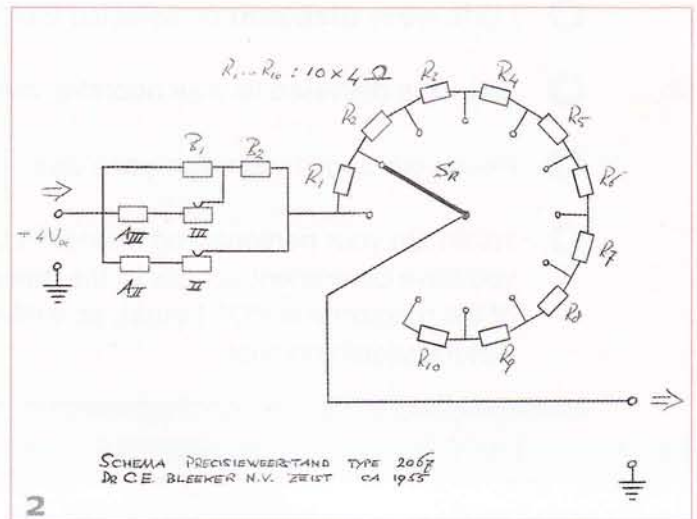
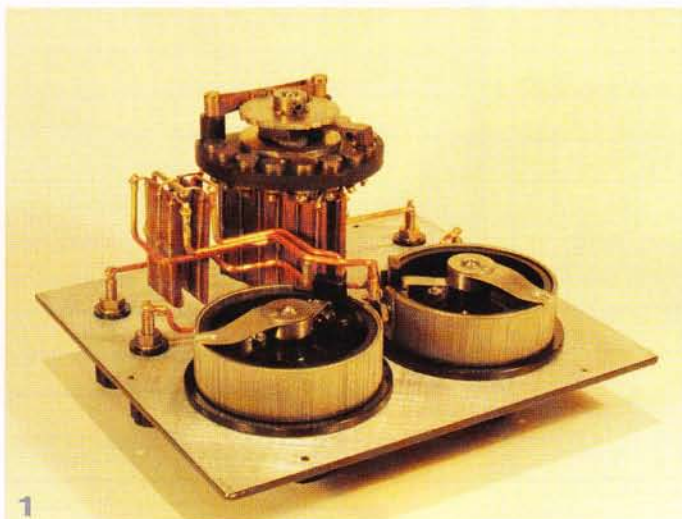

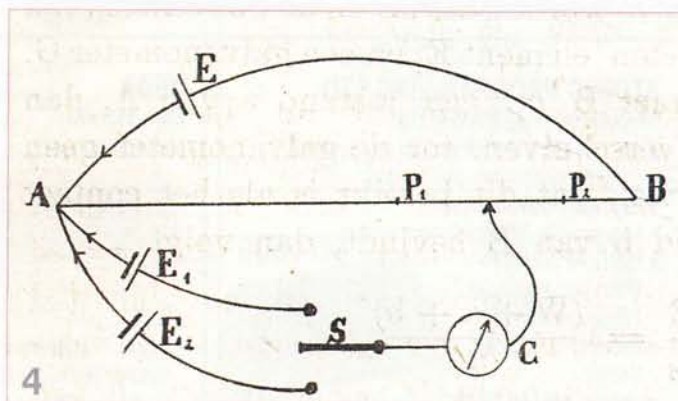
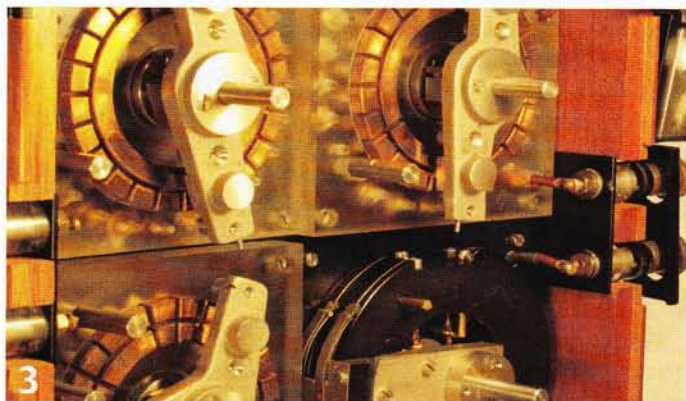

front: published in Delft — in 1902! I hadn't expected that I would have to go so far back in time. This isn't retronics, it's retro-electrics! However, its operation was clearly explained.

Conductor AB is a long wire with a high resistance, to which a voltage E is applied (Figure 4). The two voltages to be compared (E1 and E2) are connected as indicated in the diagram, and S1 is a moveable contact. Using this arrangement, you can determine the two points P1 and P2 (corresponding to the voltages E1 and E2) where no current flows through the meter circuit. Then you have:

$$\frac{E_1}{E_2} = \frac{\text{resistance of } AP_1}{\text{resistance of } AP_2}$$

The ratio of the resistances is the same as the ratio of the lengths. Now suppose you replace one section of the wire with a resistor box. If you adjust point C to zero the meter, this also affects the resistance of conductor AB, but if you connect two identical resistor boxes in series with point C between them, you can zero the meter while maintaining the total resistance constant by reducing the resistance of one box and increasing the resistance of the other box by the same amount. Although this is a simple procedure, it is prone to error. According to my book from 1902, with a compensator 'the mutually compensating adjustment of the two resistances takes place automatically, so the resistance between the two end terminals is always constant. If you examine the current flow in Figure 5, you can see immediately that regardless of how the knobs are set, the resistance between terminals +B and -B remains constant

at 14999.9 Ω, while any desired resistance from 0.1 to 14999.9 Ω can be set between points +D and -D; the numbers next to the knobs indicate directly the value of this resistance.' **A marvel of ingenuity!**

Further on in the same book I discovered the purpose of the precision resistance: it was used 'to obtain an accurately known current, necessary for the calibration of some types of equipment'. This fitted with the origin of these instruments: the former owner manufactured gas analysers, and they need to be calibrated at regular intervals (even today).

With regard to the instrument manufacturer, the physicist Dr Caroline Emilie Bleeker was the first person in the Netherlands to establish a physics consulting firm (in 1930). This led to the founding of an instrument factory that produced optical, electrical and medical instruments. Its history is a separate story, but in conclusion I would like to quote a couple of sentences from Bleeker herself, from a staff newsletter published in May 1948:

'Everybody contributes to all of the instruments. [For many years, she performed the final inspections herself - RB] The one may make more difficult components than the other, but every component is important, and only if everyone does their own work as well as possible can we collectively produce something. The instruments that bear the name of our factory may perhaps still be there when we have passed away, and then they will bear testimony to how we did our work.' How right she was!

(090947)

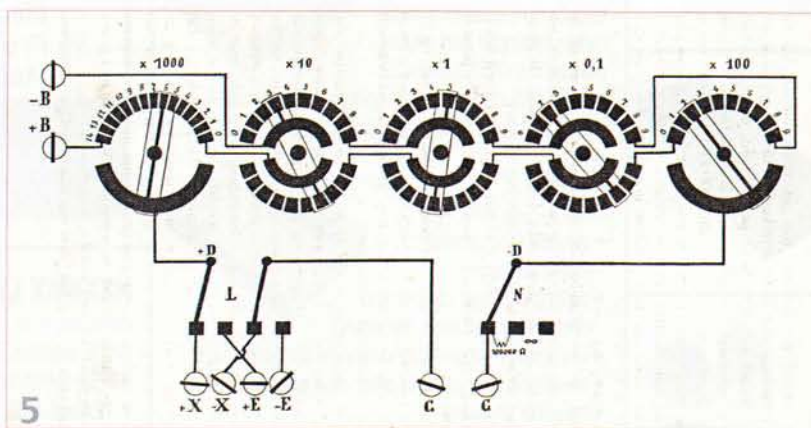

Retronics is a monthly column covering vintage electronics including legendary Elektor designs. Contributions, suggestions and requests are welcomed; please send an email to editor@elektor.com

ELEKTOR SHOWCASE

To book your showcase space contact Huson International Media

Tel. 0044 (0) 1932 564999 Fax 0044 (0) 1932 564998

ATOMIC PROGRAMMING LTD

www.atomicprogramming.com

- AP-114 ISP/JTAG Programming System
- JTAG Programming and Testing
- Boundary Scan Testing
- Universal In-System Programming
- EEPROM and SPI Flash Out-of-Circuit Programming
- Generic GDB Proxy Server
- Jennic JN5148 ZigBee Development Applications
- Training Platform available



CEDA

www.ceda.in

ceda@vsnl.com

CEDA e-learning
PADS | OrCAD | ALLEGRO
PCB layout @ \$5 Hourly

- PCB Layout @ \$5 Hourly
- Learn PCB Designing with Multimedia DVD in OrCAD, PADS & ALLEGRO
- Self or e-learning with support by email, phone & web-meeting

FIRST TECHNOLOGY TRANSFER LTD.

<http://www.ftt.co.uk>

- Training and Consulting for IT, Embedded and Real Time Systems
- Assembler, C, C++ (all levels)
- 8, 16 and 32 bit microcontrollers
- Microchip, ARM, Renesas, TI, Freescale
- CMX, uCOSII, FreeRTOS, Linux operating systems
- Ethernet, CAN, USB, TCP/IP, Zigbee, Bluetooth programming



AVIT RESEARCH

www.avitresearch.co.uk

USB has never been so simple... with our USB to Microcontroller Interface cable. Appears just like a serial port to both PC and Microcontroller, for really easy USB connection to your projects, or replacement of existing RS232 interfaces.



See our webpage for more details. From £10.00.

DESIGNER SYSTEMS

<http://www.designersystems.co.uk>

Professional product development services.

- Marine (Security, Tracking, Monitoring & control)
 - Automotive (AV, Tracking, Gadget, Monitoring & control)
 - Industrial (Safety systems, Monitoring over Ethernet)
 - Telecoms (PSTN handsets, GSM/GPRS)
 - AudioVisual ((HD)DVD accessories & controllers)
- Tel: +44 (0) 845 5192306

FLEXIPANEL LTD

www.flexipanel.com

TEAclippers - the smallest PIC programmers in the world, from £20 each:

- Per-copy firmware sales
- Firmware programming & archiving
- In-the-field firmware updates
- Protection from design theft by subcontractors



BETA LAYOUT

www.pcb-pool.com

Beta layout Ltd Award-winning site in both English and German offers prototype PCBs at a fraction of the cost of the usual manufacturer's prices.



EASYDAQ

www.easydaq.biz

- USB powered, 4 relays + 4 DIO channels
- Will switch 240VAC @ 10A
- LabVIEW, VB, VC, C#, Java
- Screw terminal access
- Free shipping
- From £38

Design & supply of USB, Wireless, LAN, Internet & Serial Relay, DIO & DAQ products.
info@easydaq.biz



FUTURE TECHNOLOGY DEVICES

<http://www.ftdichip.com>

FTDI designs and sells USB-UART and USB-FIFO interface i.c.'s.

Complete with PC drivers, these devices simplify the task of designing or upgrading peripherals to USB



BLACK ROBOTICS

www.blackrobotics.com

Robot platforms and brains for research, hobby and education.



- Make your robot talk!
- TalkBotBrain is open-source
- Free robot speech software
- Robot humanisation technology
- Mandibot Gripper Robot

EASYSYNC

<http://www.easysync.co.uk>

EasySync Ltd sells a wide range of single and multi-port USB to RS232/RS422 and RS485 converters at competitive prices.



ByVac

www.byvac.com

- PIC32 With BASIC
- ARM With Forth
- USB to I2C
- Serial Devices
- VT100 LCD Displays



ELNEC

www.elnec.com

- device programmer manufacturer
- selling through contracted distributors all over the world
- universal and dedicated device programmers
- excellent support and after sale support
- free SW updates
- reliable HW
- once a months new SW release
- three years warranty for most programmers



DECIBIT CO.LTD

www.decibit.com

- Development Kit 2.4 GHz
- Transceiver nRF24L01
- AVR MCU ATmega168



HAMEG® Instruments

A Rohde & Schwarz Company

- Oscilloscopes
- Power Supplies
- Radio Frequency Measuring Instruments
- Programmable Measuring Instruments

Great Value in Test & Measurement

www.hameg.com

HEXWAX LTD

www.hexwax.com

World leaders in Driver-Free USB ICs:

- USB-UART/SPI/I2C bridges
- TEAleaf-USB authentication dongles
- expandIO-USB I/O USB expander
- USB-FileSys flash drive with SPI interface
- USB-DAQ data logging flash drive

products and services directory

LONDON ELECTRONICS COLLEGE

<http://www.lec.org.uk>

Vocational training and education for national qualifications in Electronics Engineering and Information Technology (BTEC First National, Higher National NVQs, GCSEs and GCEs). Also Technical Management and Languages.



MQP ELECTRONICS

www.mqp.com

- Low cost USB Bus Analysers
- High, Full or Low speed captures
- Graphical analysis and filtering
- Automatic speed detection
- Bus powered from high speed PC
- Capture buttons and feature connector
- Optional analysis classes



www.elektor.com

RFID COMPONENTS

<http://www.apdanglia.org.uk>

For DIY, OEM's & Experimenters

- EM4100 Cards .99 p (Prices inc vat)
 - Keyfobs £1.09
 - R/W Keyfobs £1.65
 - RFID Coils £2.95
 - RFID PCB with RS232 port
 - RFID IC's EM4095 - U2270B
 - microRFID module (similar to Core ID12)
 - Free Reader download - Technical pages
- Order online 24 hrs - Tel: 01244 520684



ROBOT ELECTRONICS

<http://www.robot-electronics.co.uk>

Advanced Sensors and Electronics for Robotics

- Ultrasonic Range Finders
- Compass modules
- Infra-Red Thermal sensors
- Motor Controllers
- Vision Systems
- Wireless Telemetry Links
- Embedded Controllers



ROBOTIQ

<http://www.robotiq.co.uk>

Build your own Robot!

Fun for the whole family!

Now, available in time for X-mas

- Arduino Starter Kits *NEW!!*
 - Lego NXT Mindstorms
 - Affordable Embedded Linux Boards
 - Vex Robotics (kits and components)
 - POB Robots (kits and components)
- email: sales@robotiq.co.uk Tel: 020 8669 0769



USB INSTRUMENTS

<http://www.usb-instruments.com>

USB Instruments specialises in PC based instrumentation products and software such as Oscilloscopes, Data Loggers, Logic Analysers which interface to your PC via USB.



VIRTINS TECHNOLOGY

www.virtins.com

PC and Pocket PC based virtual instrument such as sound card real time oscilloscope, spectrum analyzer, signal generator, multimeter, sound meter, distortion analyzer, LCR meter. Free to download and try.



www.elektor.com

SHOWCASE YOUR COMPANY HERE

Elektor Electronics has a feature to help customers promote their business, Showcase - a permanent feature of the magazine where you will be able to showcase your products and services.

- For just £242 + VAT (£22 per issue for eleven issues) Elektor will publish your company name, website address and a 30-word description
- For £363 + VAT for the year (£33 per issue for eleven issues) we will publish the above plus run a 3cm deep full colour

image - e.g. a product shot, a screen shot from your site, a company logo - your choice

Places are limited and spaces will go on a strictly first come, first served basis. So-please fax back your order today!

I wish to promote my company, please book my space:

- Text insertion only for £242 + VAT
- Text and photo for £363 + VAT

NAME: ORGANISATION:

JOB TITLE:

ADDRESS:

TEL:

PLEASE COMPLETE COUPON BELOW AND FAX BACK TO 00-44-(0)1932 564998

COMPANY NAME

WEB ADDRESS

30-WORD DESCRIPTION

Going Strong

A world of electronics from a single shop!

NEW!

The international electronics magazine



elektor

Annual
Jahrgang
Année
Jaargang
Anual

All articles from Volume 2009 on DVD-ROM

Complete your collection now!
20% DISCOUNT PER CD/DVD
www.elektor.com/march



Bestseller!

110 issues, more than 2,100 articles

DVD Elektor 1990 through 1999

This DVD-ROM contains the full range of 1990-1999 volumes (all 110 issues) of Elektor Electronics magazine (PDF). The more than 2,100 separate articles have been classified chronologically by their dates of publication (month/year), but are also listed alphabetically by topic. A comprehensive index enables you to search the entire DVD.

ISBN 978-0-905705-76-7

£69.00 • US \$111.30



See the light on Solid State Lighting

DVD LED Toolbox

This DVD-ROM contains carefully-sorted comprehensive technical documentation about and around LEDs. For standard models, and for a selection of LED modules, this Toolbox gathers together data sheets from all the manufacturers, application notes, design guides, white papers and so on. It offers several hundred drivers for powering and controlling LEDs in different configurations, along with ready-to-use modules (power supply units, DMX controllers, dimmers, etc.). In addition to optical systems, light detectors, hardware, etc., this DVD also addresses the main shortcoming of power LEDs: heating. This DVD contains several Elektor articles (more than 100) on the subject of LEDs.

ISBN 978-90-5381-245-7

£28.50 • US \$46.00

CD/DVD-ROMs

All articles from Elektor Volume 2009 on DVD-ROM

DVD Elektor 2009

The year volume DVD/CD-ROMs are among the most popular items in Elektor's product range. This DVD-ROM contains all editorial articles published in Volume 2009 of the English, American, Spanish, Dutch, French and German editions of Elektor. Using the supplied Adobe Reader program, articles are presented in the same layout as originally found in the magazine. An extensive search machine is available to locate keywords in any article. With this DVD you can also produce hard copy of PCB layouts at printer resolution, adapt PCB layouts using your favourite graphics program, zoom in / out on selected PCB areas and export circuit diagrams and illustrations to other programs.

ISBN 978-90-5381-251-8 • £17.50 • US \$28.30



Modern technology for everyone

FPGA Course

FPGAs have established a firm position in the modern electronics designer's toolkit. Until recently, these 'super components' were practically reserved for specialists in high-tech companies. The nine lessons on this courseware CD-ROM are a step by step guide to the world of Field Programmable Gate Array technology. Subjects covered include not just digital logic and bus systems but also building an FPGA webserver, a 4-channel multimeter and a USB controller. The CD also contains PCB layout files in pdf format, a Quartus manual, project software and various supplementary instructions.

ISBN 978-90-5381-225-9
£14.50 • US \$23.40



Completely updated

Elektor's Components Database 5

The program package consists of eight databanks covering ICs, germanium and silicon transistors, FETs, diodes, thyristors, triacs and optocouplers. A further eleven applications cover the calculation of, for example, LED series droppers, zener diode series resistors, voltage regulators and AMVs. A colour band decoder is included for determining resistor and inductor values. ECD 5 gives instant access to data on more than 69,000 components. All databank applications are fully interactive, allowing the user to add, edit and complete component data.

ISBN 978-90-5381-159-7
£24.90 • US \$40.20

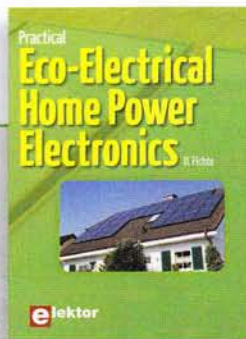

Look into the electronics of eco-power

Practical Eco-Electrical Home Power Electronics

This book is a sequel to *Your own Eco-Electrical Home Power System* and goes deeper into the electronics of photovoltaic and thermal solar technologies, wind power conversion, inverter circuits, and loads such as electronic lighting. Power electronics circuit theory is presented while analyzing commercial circuits, including little-known converters and subtleties such as snubbers and leakage inductance. The book also offers in-depth coverage of power system strategizing for optimal efficiency and utility, including a 170 V DC bus, commercial solar charger design with detailed circuit explanations, wind generator electric machine electromechanical theory, wind converter design requirements and the series-L zero-current-switching converter and power supplies found inside loads connected to home power systems and their potential problems and consequences for inverters.

192 pages • ISBN 978-0-905705-83-5
£24.90 • US \$40.20

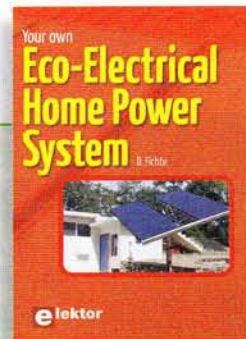

Home electric power

Your own Eco-Electrical Home Power System

This book provides the semi-technical, power-conscious homeowner a place to begin in the quest for home electric power. Both the essential principles and detailed information on how to build or maintain a home electric system off the utility grid are presented in an easy-going style. This booklet will help you to safeguard or develop your own home electricity supply. It contains step-by-step calculations, practical details, examples and much more.

96 pages • ISBN 978-0-905705-82-8
£16.50 • US \$26.70

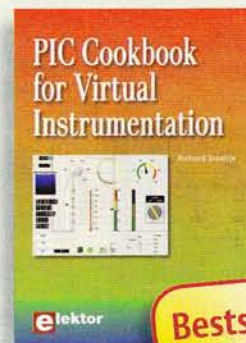

Bestseller!

Several case studies included

PIC Cookbook for Virtual Instrumentation

The software simulation of gauges, control-knobs, meters and indicators which behave just like real hardware components on a PC's screen is known as virtual instrumentation. In this book, the Delphi program is used to create these mimics and PIC based external sensors are connected via a USB/RS232 converter communication link to a PC. Case studies of virtual instruments are detailed including a compass, an oscilloscope, a digital and analogue thermometer and virtual displays for cars and aircraft.

264 pages • ISBN 978-0-905705-84-2
£29.50 • US \$47.60

More information on the
Elektor Website:
www.elektor.com

Elektor
Regus Brentford
1000 Great West Road
Brentford
TW8 9HH
United Kingdom
Tel.: +44 20 8261 4509
Fax: +44 20 8261 4447
Email: sales@elektor.com

elektor

Books

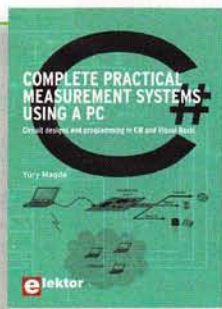

Circuit design and programming

Complete practical measurement systems using a PC

This book covers both hardware and software aspects of designing typical embedded systems based on personal computers running the Windows operating system. It's use of modern techniques in detailed, numerous examples has been designed to show clearly how straightforward it can be to create the interfaces between digital and analog electronics, programming and Web-design. Readers are encouraged by examples to program with ease; the book provides clear guidelines as to the appropriate programming techniques "on the fly".

292 pages • ISBN 978-0-905705-79-8
 £28.50 • US \$46.00



Learn more about C# programming and .NET

C# 2008 and .NET programming

This book is aimed at Engineers and Scientists who want to learn about the .NET environment and C# programming or who have an interest in interfacing hardware to a PC. The book covers the Visual Studio 2008 development environment, the .NET framework and C# programming language from data types and program flow to more advanced concepts including object oriented programming.

240 pages • ISBN 978-0-905705-81-1
 £29.50 • US \$47.60



New!

WinAmp Controller

(February 2010)

A variety of remote control devices for Winamp and other PC-based media players have been available for a good while. All of these systems have one thing in common, which is that they are limited to buttons or keys or use virtual progress bars on the computer monitor. If you want to have a complete hardware interface unit with the same level of sophistication as the virtual Winamp design, you need a physical progress bar. In this project a small ATmega microcontroller uses the USB interface to provide a bidirectional link between the Winamp software and a hardware studio fader, which acts as a combined indicator and entry device.

Kit of parts, including PCB

Art.# 090531-71 • £85.00 • US \$143.60



MIAC for Home Automation

(January 2010)

A MIAC is an industrial programmable logic controller (PLC) that can be used in a wide variety of electronic systems. Internally it has a powerful 18F4455 PIC microcontroller which is connected directly to a USB port. As a result it can be easily programmed using either Flowcode, C or assembly. The article in Elektor's January 2010 issue shows how to implement a simple home automation system with an alarm by using three MIACs.

Populated PCB in enclosure

Art.# 090278-91 • £154.00 • US \$248.40



Bestseller!

Preselector for Elektor SDR

(December 2009)

Elektor's Software Defined Radio (SDR) is deservedly popular. The performance of a receiver depends to a large extent on its input filters. A selective input circuit improves antenna matching and immunity to interference from other strong signals. This preselector allows the use of up to four filters, tuned under software control using varicap diodes. A tuned loop antenna is also described that lets you use our SDR without an outdoor antenna.

Kit of parts, contains partly populated board, coil formers, ferrite rod with coils

Art.# 090615-71 • £47.00 • US \$75.90



OBD Analyser NG

(September 2009)

The compact OBD2 Analyser in the June 2007 issue was an enormous success – not surprising for an affordable handheld onboard diagnostics device with automatic protocol recognition and error codes explained in plain language. Now enhanced with a graphical display, Cortex M3 processor and an Open Source user interface, the next generation of Elektor's standalone analyser sets new standards for a DIY OBD2 project. The key advantage of this OBD2 Analyser NG is that it's self-contained and can plug into any OBD diagnostic port.

Kit of parts including DXM Module, PCB SMD-prefitted, case, mounting materials and cable

Art.# 090451-71 • £84.00 • US \$135.50

March 2010 (No. 399)

£ US \$

+ + + Product Shortlist March: See www.elektor.com + + +

February 2010 (No. 398)

Battery Checker

071131-41 ATmega32-16PU, programmed 17.80.....28.80
071131-71 Kit of parts, excl. enclosure.....www.elektor.com

Winamp Controller

090531-71 Kit of parts 89.00.....143.60

The ATM18 Radio Computer

090740-71 PCB with Si4734/35 radio IC ready
mounted and tested..... 27.50.....44.40

January 2010 (No. 397)

USB Magic Eye

090788-1 Printed circuit board..... 9.90.....16.00
090788-41 ATtiny2313-20PU, programmed 9.90.....16.00

MIAC for Home Automation

090278-91 Populated PCB in enclosure 154.00.....248.40

Dimmer with a Micro

090315-41 PIC12F629A, programmed..... 7.60.....12.30

December 2009 (No. 396)

Preselector for Elektor SDR

090615-71 Kit of parts, contains partly populated board,
coil formers, ferrite rod with coils..... 47.00.....75.90

Top-of-the-Bill Lights Sequencer

090125-1 PCB, bare (master module)..... 10.80.....17.50
090125-2 PCB, bare (lamp module)..... 2.30.....3.80
090125-41 Controller (PIC18F2550)
for main PCB, programmed 14.50.....23.40
090125-42 Controller (PIC12F508-I/SN)
for lamp unit, programmed..... 2.30..... 3.80

The Vikings Are Coming!

080948-71 Kit of parts: bare PCB and
bluetooth module BTM222 23.70.....38.30

Minimalistic Time Switch

090823-41 PIC12F683-I/SN, programmed 6.50.....10.50

November 2009 (No. 395)

Solder Station 'Plus'

090022-41 PIC18F4520, programmed..... 11.50.....18.60

AVR-Max Chess Computer

081101-1 Printed circuit board..... 12.90.....20.90
081101-41 Programmed controller ATmega88 11.50.....18.60
081101-71 Kit of parts incl. PCB,
programmed controller and components..... 29.90.....48.30

R32C Web Server

080082-71 Application Board with SMD parts prefitted,
plus all other components 124.50.....200.90
080928-91 R32C Starter Kit: processor board populated
and tested, Toolchain on CD 27.00.....43.60
090607-71 PCB, populated and tested WIZ812MJ module
with W5100 chip..... 18.00.....29.10

October 2009 (No. 394)

Pocket Preamp

080278-71 Kit of parts 65.00.....104.90

Digital Barometric Altimeter

080444-41 PIC18F2423, programmed..... 15.00.....24.20

September 2009 (No. 393)

R32C Application Board

080082-71 Kit of parts including Application Board with
SMD parts prefitted, plus all other components 124.50.....200.90
080928-91 R32C Starterkit: Processor board populated
and tested, Toolchain on CD 27.00.....43.60

Bestsellers

Books	1	PIC Cookbook for Virtual Instrumentation ISBN 978-0-905705-84-2..... £29.50US \$47.60
	2	Complete practical measurement using a PC ISBN 978-0-905705-79-8..... £28.50US \$46.00
	3	Practical Eco-Electrical Home Power Electronics ISBN 978-0-905705-83-5..... £24.90US \$40.20
	4	C# 2008 and .NET programming ISBN 978-0-905705-81-1..... £29.50US \$47.60
	5	Your own Eco-Electrical Home Power System ISBN 978-0-905705-82-8..... £16.50US \$26.70
CD/DVD-ROMs	1	DVD Elektor 1990 through 1999 ISBN 978-0-905705-76-7..... £69.00 ...US \$111.30
	2	DVD LED Toolbox ISBN 978-90-5381-245-7..... £28.50US \$46.00
	3	FPGA Course ISBN 978-90-5381-225-9..... £14.50US \$23.40
	4	ECD 5 ISBN 978-90-5381-159-7..... £24.90US \$40.20
	5	Ethernet Toolbox ISBN 978-90-5381-214-3..... £19.50 US \$31.50
Kits & Modules	1	SDR Preselector Art. # 090615-71 £47.00 US \$75.90
	2	R32C/111 Starterkit Art. # 080928-91 £27.00US \$43.60
	3	MIAC for Home Automation Art. # 090607-91 £154.00 ...US \$248.40
	4	WinAmp Controller Art. # 090531-71 £85.00 ...US \$143.60
	5	R32C Application Board Art. # 080082-71 £124.50 ...US \$200.90

Order quickly and securely through
www.elektor.com/shop
or use the Order Form near the end
of the magazine!

elektor
Elektor
Regus Brentford
1000 Great West Road
Brentford TW8 9HH • United Kingdom
Tel. +44 20 8261 4509
Fax +44 20 8261 4447
Email: sales@elektor.com



SMD Tweezers

Sure, SMD parts are widely used and accepted for high volume production, but increasingly in prototypes and DIY projects also. In view of the small size, it's useful to have purpose designed tweezers available for manual positioning of these tiny parts. Several ingenious test instruments are on the market that allow the value of the SMD part to be 'seen' while you hold it in the tweezers. For the April 2010 issue we've tested a number of these tools, including all-in-one SMD tweezers as well as meters with a separate pair of tweezers.

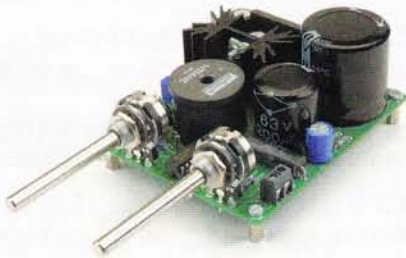

Universal Benchtop Supply

An adjustable power supply is a must-have instrument if you're serious about your experiments in the electronics lab — preferably a symmetrical supply, with clear meters for output current and voltage. Our small switch-mode supply allows these wishes to come true fairly easily. The circuit supplies 0 to 25 V at up to 3 A with voltage and current controls. Depending on your requirements, either one or two boards can be built for a benchtop supply with single or dual output supplies.

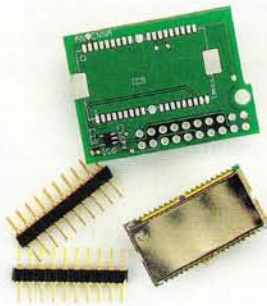

Wireless OBD-2 Analyser

The 'OBD Analyser NG' published last September is a great tool for extracting data and fault conditions from motor vehicles. Now we present an extension to this module that allows the control and readout of OBD data to be handled wirelessly from a laptop PC. This allows vehicle data to be captured and logged in a file while driving.

We regret that "ATM18 VisiOLED" could not be published in the March 2010 issue as planned.

*Article titles and magazine contents subject to change; please check the Magazine tab on www.elektor.com
Elektor UK/European edition: on sale March 18, 2010. Elektor USA edition: published March 11, 2010.*

www.elektor.com www.elektor.com www.elektor.com www.elektor.com www.elektor.com www.elektor.com

Elektor on the web

All magazine articles back to volume 2000 are available online in pdf format. The article summary and parts list (if applicable) can be instantly viewed to help you positively identify an article. Article related items are also shown, including software downloads, circuit boards, programmed ICs and corrections and updates if applicable. Complete magazine issues may also be downloaded.

In the Elektor Shop you'll find all other products sold by the publishers, like CD-ROMs, DVDs, kits, modules, equipment, tools and books. A powerful search function allows you to search for items and references across the entire website.

Also on the Elektor website:

- Electronics news and Elektor announcements
- Readers Forum
- PCB, software and e-magazine downloads
- Time limited offers
- FAQ, Author Guidelines and Contact

The screenshot shows the Elektor website homepage. At the top, there's a navigation bar with links for Home, News, Magazine, Shop, Subscribe now, Forum, and Service. Below this is a search bar and a 'Subject Area' dropdown menu. The main content area features several promotional boxes: 'Distance Learning Courses' with an introductory price, 'Kit of parts ElektorWheels' for power stability and fun to drive, 'Elektor Magazine' subscription information, and 'Elektor Personal Organizer' for electronics enthusiasts. There's also a 'Let your Geek Shine' banner and a 'Sparkfun' logo. The bottom of the page has a 'My Elektor' section with login and email options, and a 'FAQ' link.



GO FASTER WITH PROTEUS PCB DESIGN

The latest version of the Proteus Design Suite harnesses the power of your computer's graphics card to provide lightning fast performance. Together with unique transparency options it's now easier than ever to navigate and understand large, multi-layer boards.

PROTEUS DESIGN SUITE Features:

- Hardware Accelerated Performance.
- Unique Thru-View™ Board Transparency.
- Over 35k Schematic & PCB library parts.
- Integrated Shape Based Auto-router.
- Flexible Design Rule Management.
- Polygonal and Split Power Plane Support.
- Board Autoplacement & Gateswap Optimiser.
- Direct CAD/CAM, ODB++ & PDF Output.
- Integrated 3D Viewer with 3DS and DXF export.
- Mixed Mode SPICE Simulation Engine.
- Co-Simulation of PIC, AVR, 8051 and ARM7.
- Direct Technical Support at no additional cost.

All levels of the **Proteus Design Suite** include a world class, fully integrated shape-based autorouter at no additional cost - prices start from just £150 exc. VAT & delivery

labcenter  www.labcenter.com
Electronics

Labcenter Electronics Ltd. 53-55 Main Street, Grassington, North Yorks. BD23 5AA.
Registered in England 4692454 Tel: +44 (0)1756 753440, Email: info@labcenter.com

Visit our website or
phone 01756 753440
for more details